

DETAIL A
SCALE 1 : 9

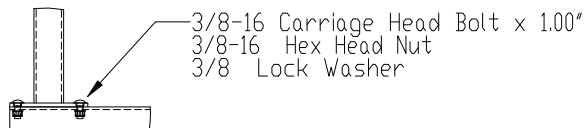

5.00 x 3.00 x .25
Mild Steel Plate
With 2 - Sq. Holes
For Carriage Bolt

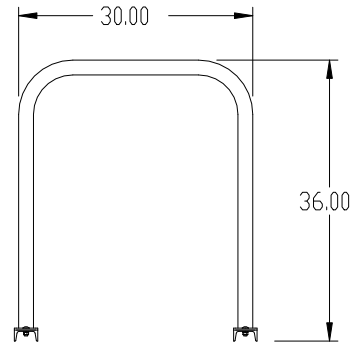
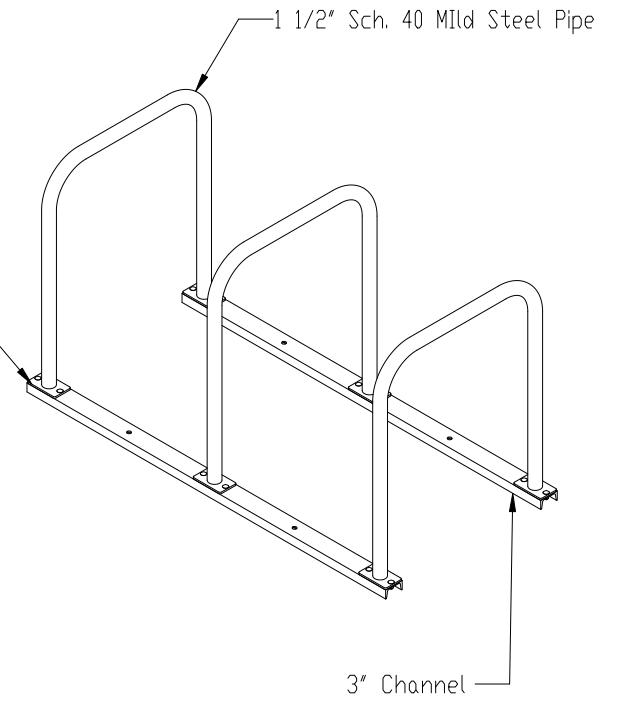

PROPRIETARY & CONFIDENTIAL	HUNTCD
THE INFORMATION CONTAINED IN THIS DRAWING IS THE SOLE PROPERTY OF HUNTCD. ANY REPRODUCTION IN PART OR AS A WHOLE WITHOUT THE WRITTEN PERMISSION OF HUNTCD IS PROHIBITED.	BIKE RACK NAME
1-800-547-5909 / WWW.HUNTCD.COM	BIKE CORRAL STAPLE-6-KD