

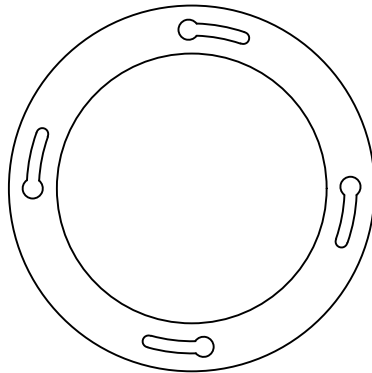

Drawing No. ES WP302

Drain Clamping Ring



Drain Base

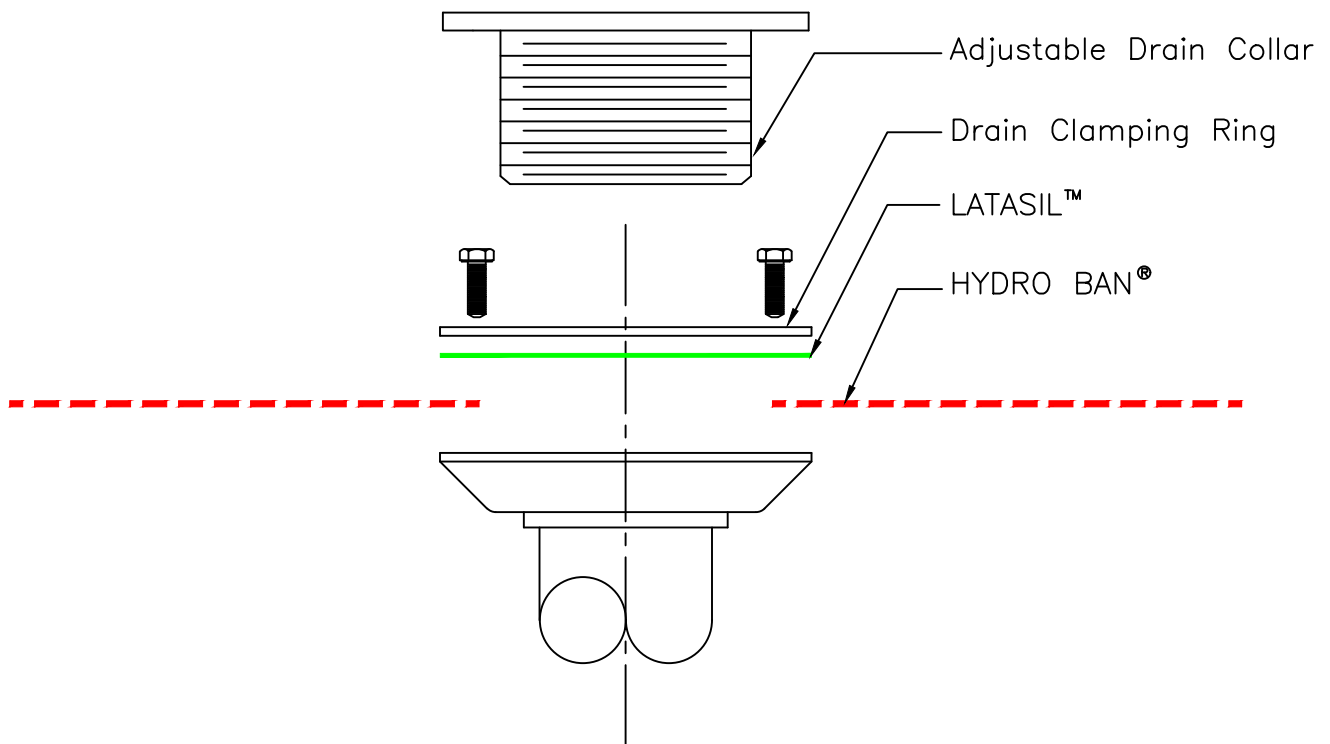
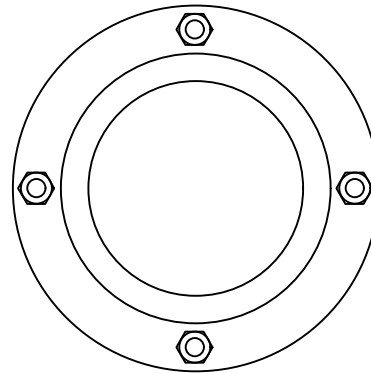

Revision Date: 2/20

Scale: N.T.S.

AS A PROFESSIONAL COURTESY, LATICRETE OFFERS TECHNICAL SERVICES FREE OF CHARGE. THE USER MAINTAINS ALL RESPONSIBILITY FOR VERIFYING THE APPLICABILITY AND SUITABILITY OF THE TECHNICAL SERVICE OR INFORMATION PROVIDED.

(C)2020 LATICRETE INTERNATIONAL, INC. ALL RIGHTS RESERVED. THE RIGHT TO UTILIZE LATICRETE DETAILS FOR COMMERCIAL PURPOSES IS GRANTED EXCLUSIVELY TO CONTRACTORS, ARCHITECTS, QUANTITY SURVEYORS, ENGINEERS, AND SPECIFICATIONS WRITERS. ALL TRADEMARKS SHOWN ARE THE INTELLECTUAL PROPERTIES OF THEIR RESPECTIVE OWNERS.