

REV.	ECN #	DESCRIPTION OF CHANGE	DATE	BY	MFG ENG
01	N/A	INITIAL RELEASE	11/07/05	SAB	

MOUNTING EMBOSS WITH 2 KEYHOLES TOP AND 2 HOLES BOTTOM, SIZED FOR 1/4" MOUNTING HARDWARE

KEYED CAMLOCK

DOOR LATCH

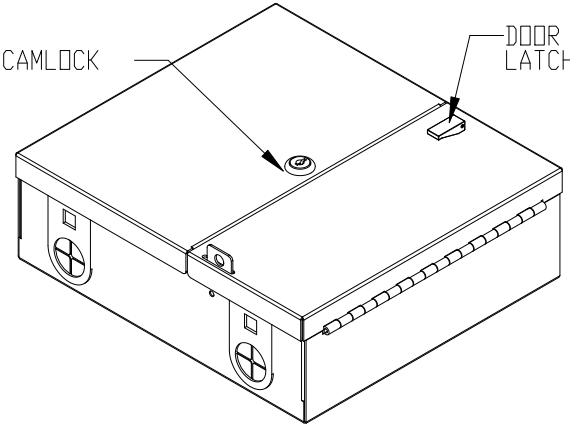

HARDWARE KIT W/KEYS

FIBER MANAGEMENT KIT

MASTER PANEL WITH PROVISIONS FOR 4 MULTIPLATES OR FIBER TERMINATION MODULES

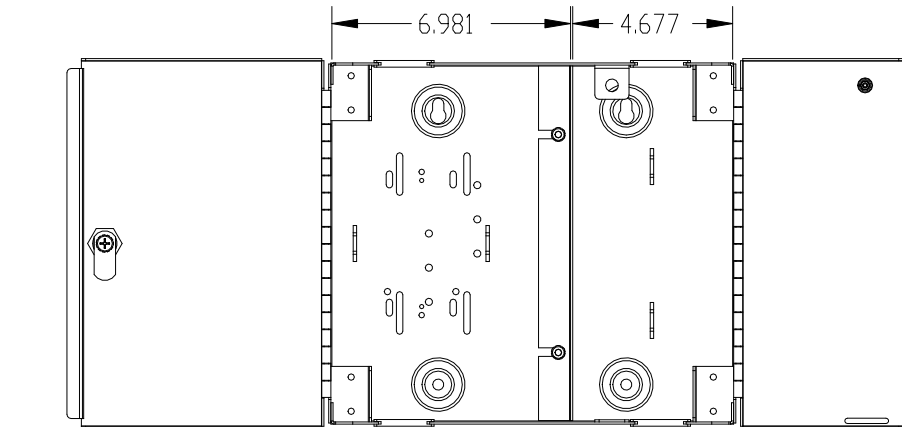
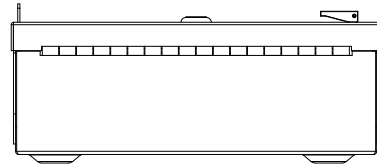
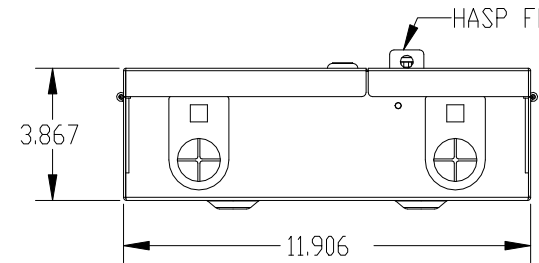
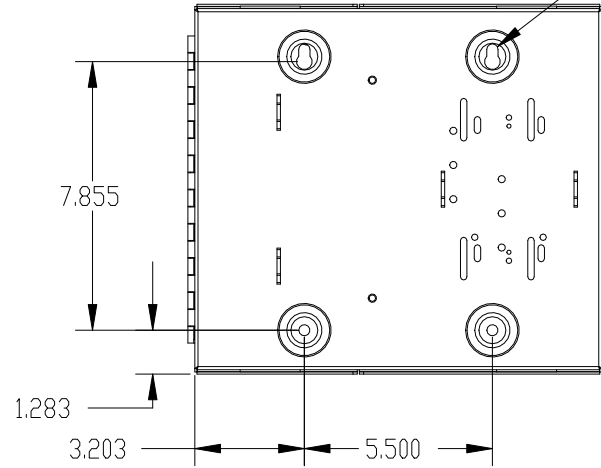
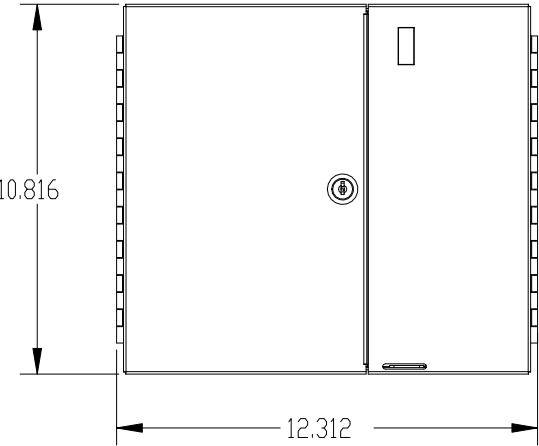
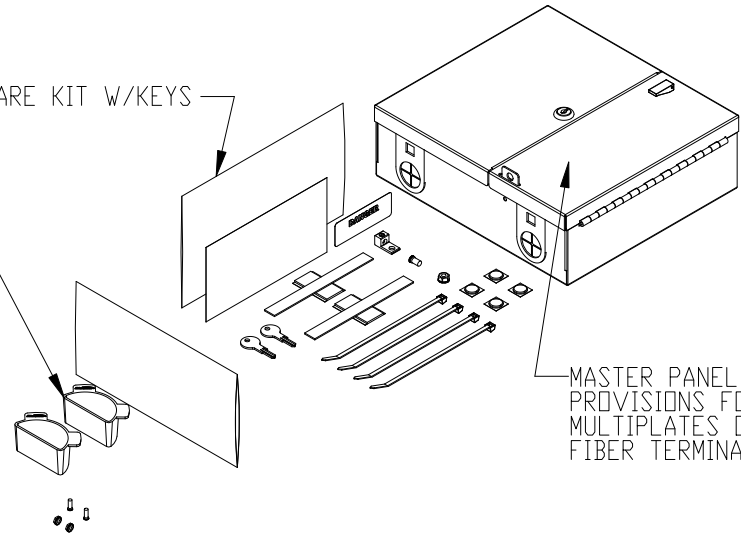

UNLESS OTHERWISE SPECIFIED DIMENSIONS ARE IN INCHES TOLERANCES ARE:		THIS DOCUMENT AND THE INFORMATION CONTAINED THEREIN ARE CONFIDENTIAL & PROPRIETARY TO MULTILINK AND MAY NOT BE COPIED OR DISCLOSED TO OTHERS WITHOUT A WRITTEN CONSENT FROM MULTILINK. THE INFORMATION IS TO BE PROMPTLY RETURNED TO MULTILINK UPON REQUEST.		m ultilink	
FRACTIONS: ±1/32	DECIMALS: .XXX ±.010	ANGLES: ±1°	ALL FLATS TO BE .005	NO SHARP EDGES OR BURRS ALLOWED	NO SHARP EDGES OR BURRS ALLOWED
MATERIAL: SEE B.O.M.	FINISH: BLACK TEXTURED	DO NOT SCALE DRAWING	DRAWN BY: SAB	DATE: 11/07/2005	CHECKED: DATE:
			MFG ENG: DATE:		
			QUALITY ENG: DATE:		
SIZE: B	DWG. NO: 99024BK-REF	REV: 03	SCALE: 1/4	CAD FILE: 99024BK-REF	1 OF 1