

REV.	ECN #	DESCRIPTION OF CHANGE	DATE	BY	MFG ENG
01	N/A	INITIAL RELEASE		JR	

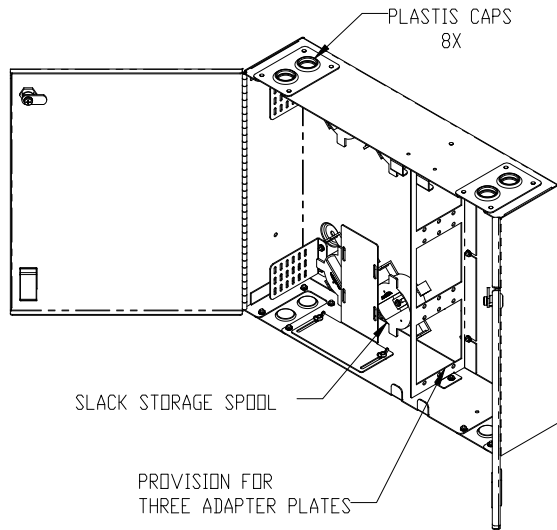
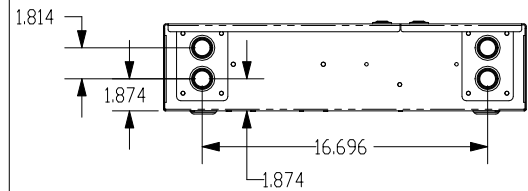
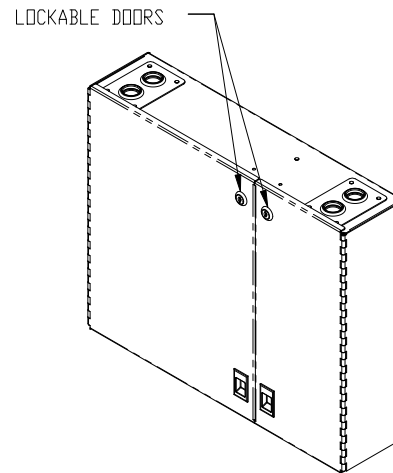
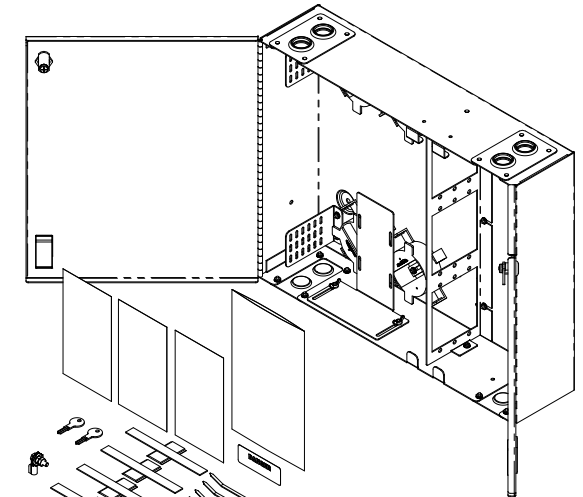
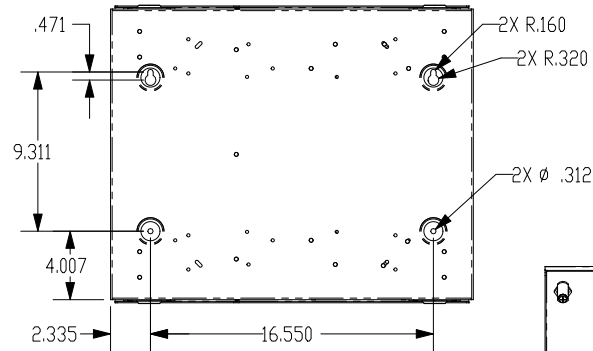
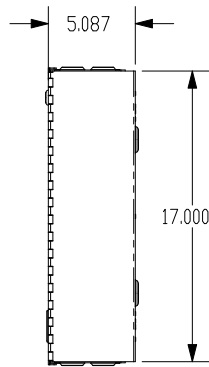
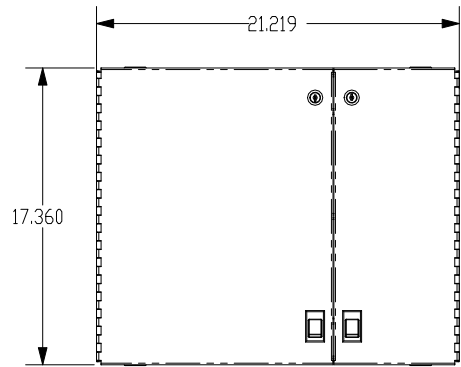

UNLESS OTHERWISE SPECIFIED DIMENSIONS ARE IN INCHES. TOLERANCES ARE: FRACTIONS: ±1/32 DECIMALS: .XXX = ±.003 ANGLES: ±1° XXX = ±.010		THIS DOCUMENT AND THE INFORMATION CONTAINED THEREIN ARE CONFIDENTIAL & PROPRIETARY TO MULTILINK AND MAY NOT BE COPIED OR DISCLOSED TO OTHERS WITHOUT A WRITTEN CONSENT FROM MULTILINK. THE INFORMATION IS TO BE PROMPTLY RETURNED TO MULTILINK UPON REQUEST.		m ultilink	
ALL FLATS TO BE .005		DRAWN BY: JR DATE: 01/09/07		FWM-9X-D-BK	
NO SHARP EDGES OR BURRS ALLOWED		CHECKED: DATE:		SIZE: B DWG. NO: 10-5283-REF REV: 08	
MATERIAL: SEE B.O.M.		MFG ENG: DATE:		SCALE: 1:8 CAD FILE: 10-5283-REF SHEET 1 OF 1	
FINISH: BLACK TEXTURED		QUALITY ENG: DATE:			
DO NOT SCALE DRAWING					