

!WARNING!

SPACE BETWEEN DOOR AND HOISTWAY MUST NOT EXCEED 3"

INTERLOCKS CONFORMING TO ASME A17.1 MUST BE INSTALLED AND ADJUSTED PER THE MANUFACTURER'S INSTRUCTIONS.

!FAILURE TO COMPLY MAY RESULT IN SERIOUS INJURY OR DEATH!

NOTE:
LEAVE ROUGH OPENING MIN 14" WIDER & 14" HIGHER THAN CLEAR OPENING, AS SHOWN.

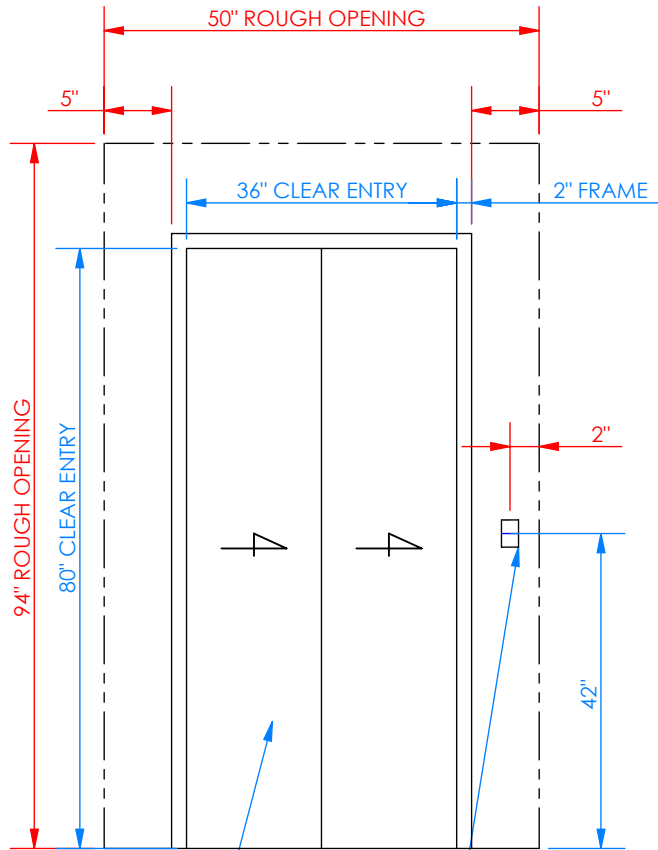

2 SPD SIDESLIDE ENTRANCE

2 1/4" WIDE X 3 3/4" HIGH
3" DEEP CUTOUT ON ALL FLOORS FOR CALL BUTTON BOX

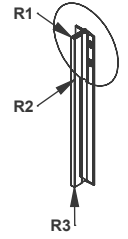
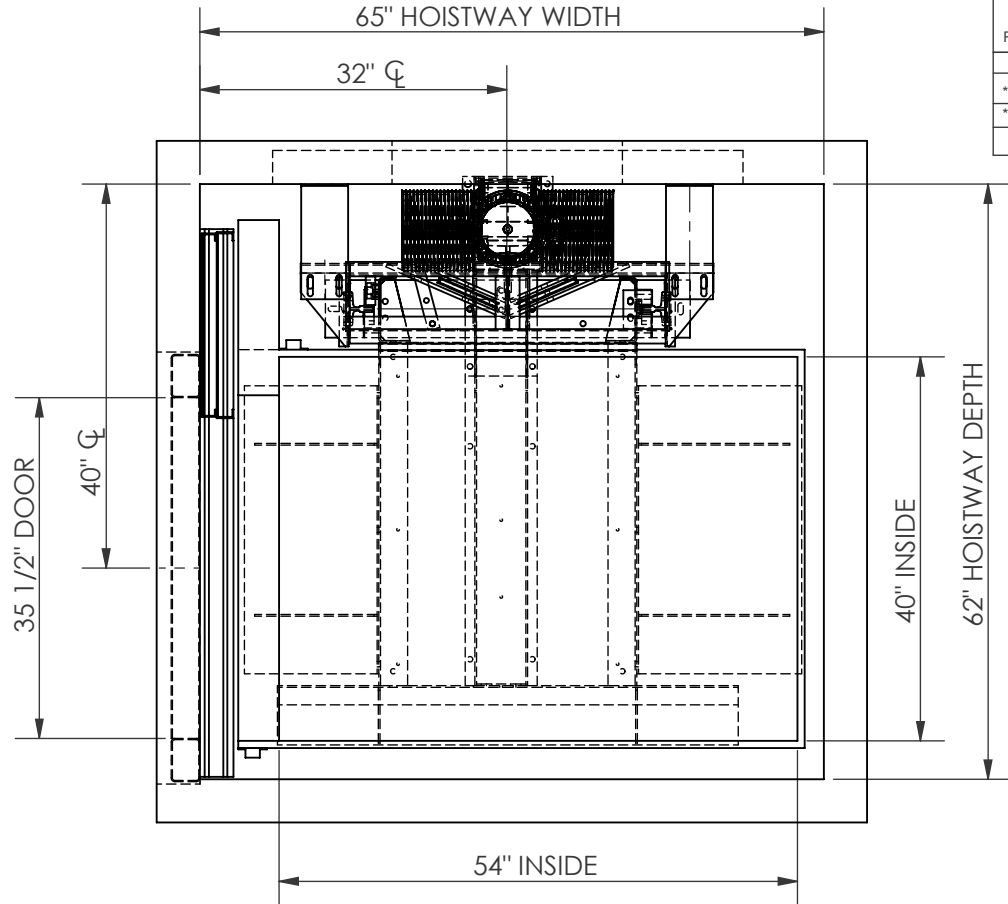

| | |
|-----------------------|----------|
| RAIL WEIGHT: 8 lbs/ft | |
| RAIL FORCES | |
| *R1(Fx) | 1075 lbs |
| *R2(Fy) | 358 lbs |
| R3(Fz) | 2500 lbs |

SIZE **A**  **Nationwide Lifts**
America's *leader* in home elevators.

PART NO.
40 X 54, 1L

SHEET 1 OF 3

DESCRIPTION:

SLIDING DOORS, BASEMENT DRUM

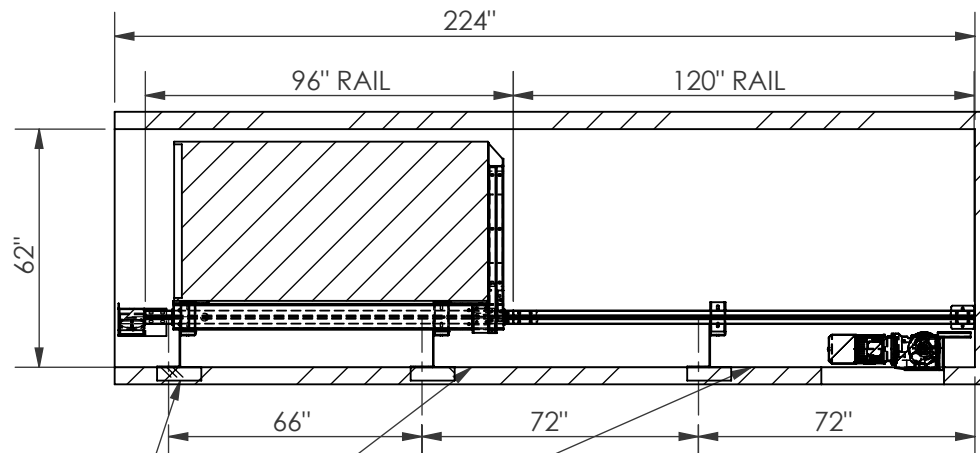

BRACKET LOCATIONS MAY VARY
ACORDING TO TRAVEL

PROVIDE WALL CONSTRUCTION
SUITABLE FOR ATTACHMENT OF
RAIL BRACKETS AT SHOWN ELEVATION.
MUST BE CAPABLE OF 300LB PULLOUT
LOADING WITH MAX DEFLECTION OF 1/8\".

SPREADER BRACKETS
FASTEN WITH LAG SCREWS
2 PLACES PER SIDE BRACKET

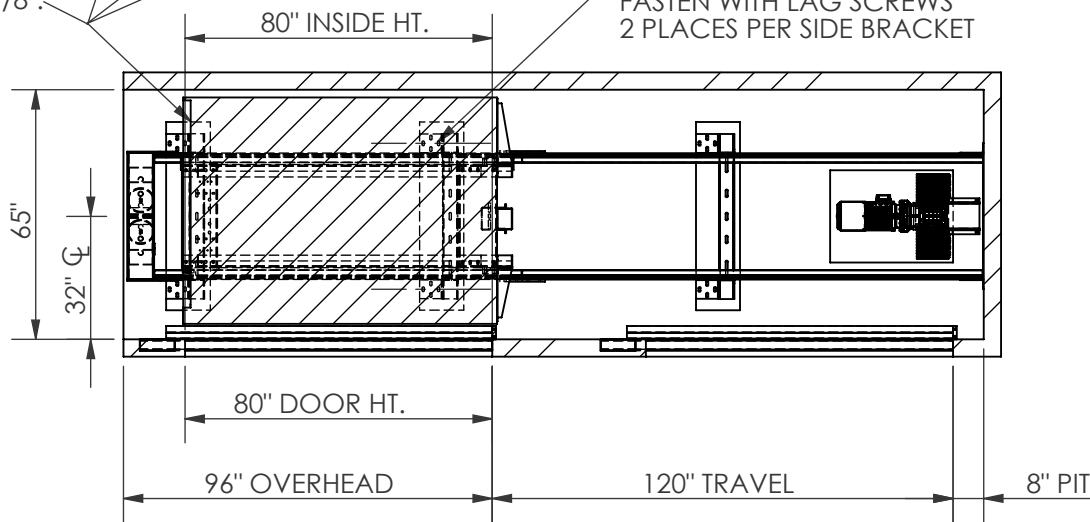

SIZE
A

Nationwide Lifts
America's *leader* in home elevators.

PART NO.
40 X 54, 1L
SHEET 2 OF 3
DESCRIPTION:
SLIDING DOORS, BASEMENT DRUM

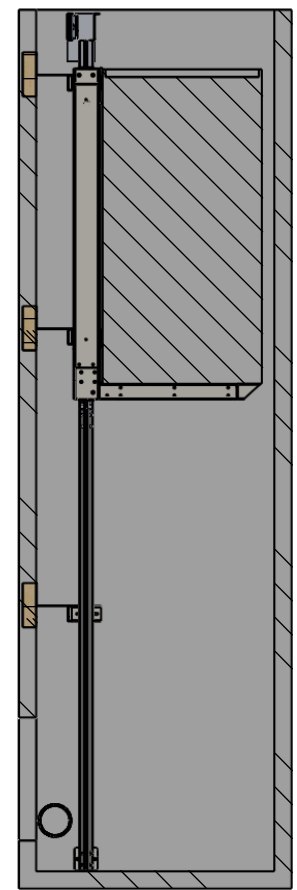
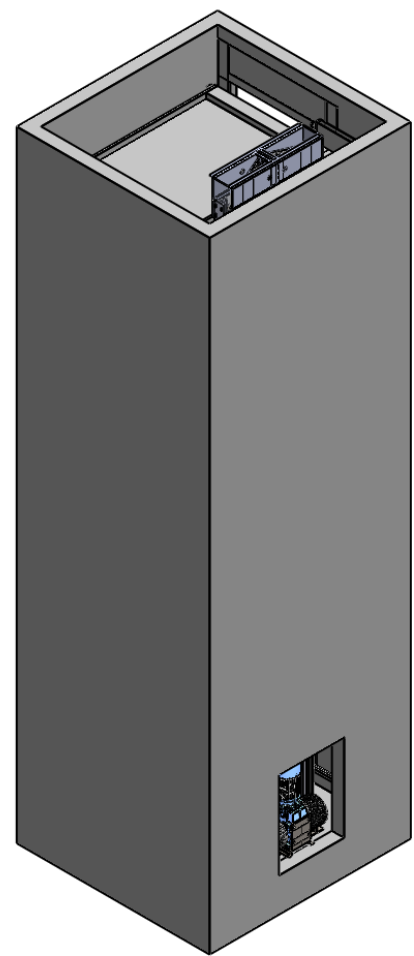
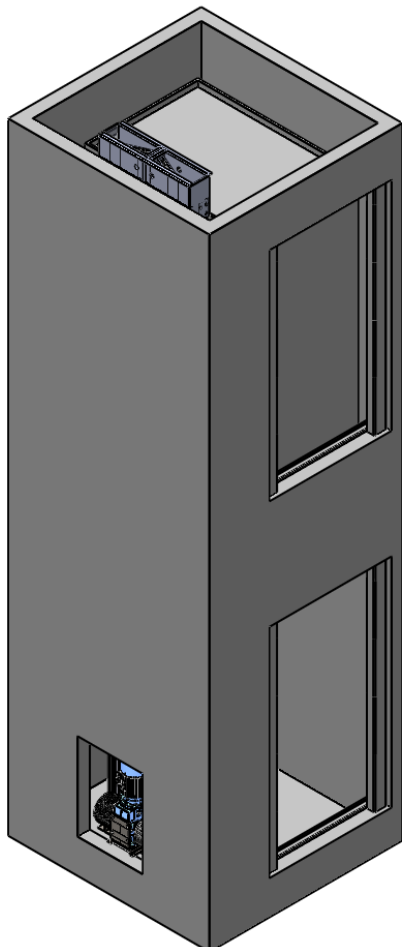

5



4

3

2

1

| | |
|------------------------------|---|
| SIZE | Nationwide Lifts <i>America's leader in home elevators.</i> |
| A | |
| PART NO. | |
| 40 X 54, 1L | |
| SHEET 3 OF 3 | |
| DESCRIPTION: | |
| SLIDING DOORS, BASEMENT DRUM | |