

NOTE: HOISTWAY WIDTH AND DISTANCE FROM PLATFORM TO HOISTWAY WALL WILL VARY BASED ON SIZE OF JACK, TRAVEL, AND CAPACITY. CONSULT DEI ENGINEERING.

*2500 LBS. 2 STAGE HOLELESS HYDRAULIC
FRONT & REAR RIGHT OPENING*

HOISTWAY PLAN
ALL DIMENSIONS ARE SUBJECT TO CHANGE WITHOUT NOTICE.
CONSULT NATIONWIDE LIFTS CO. FOR CONFIRMATION.



P: 888-695-4387, E: info@elevators.com

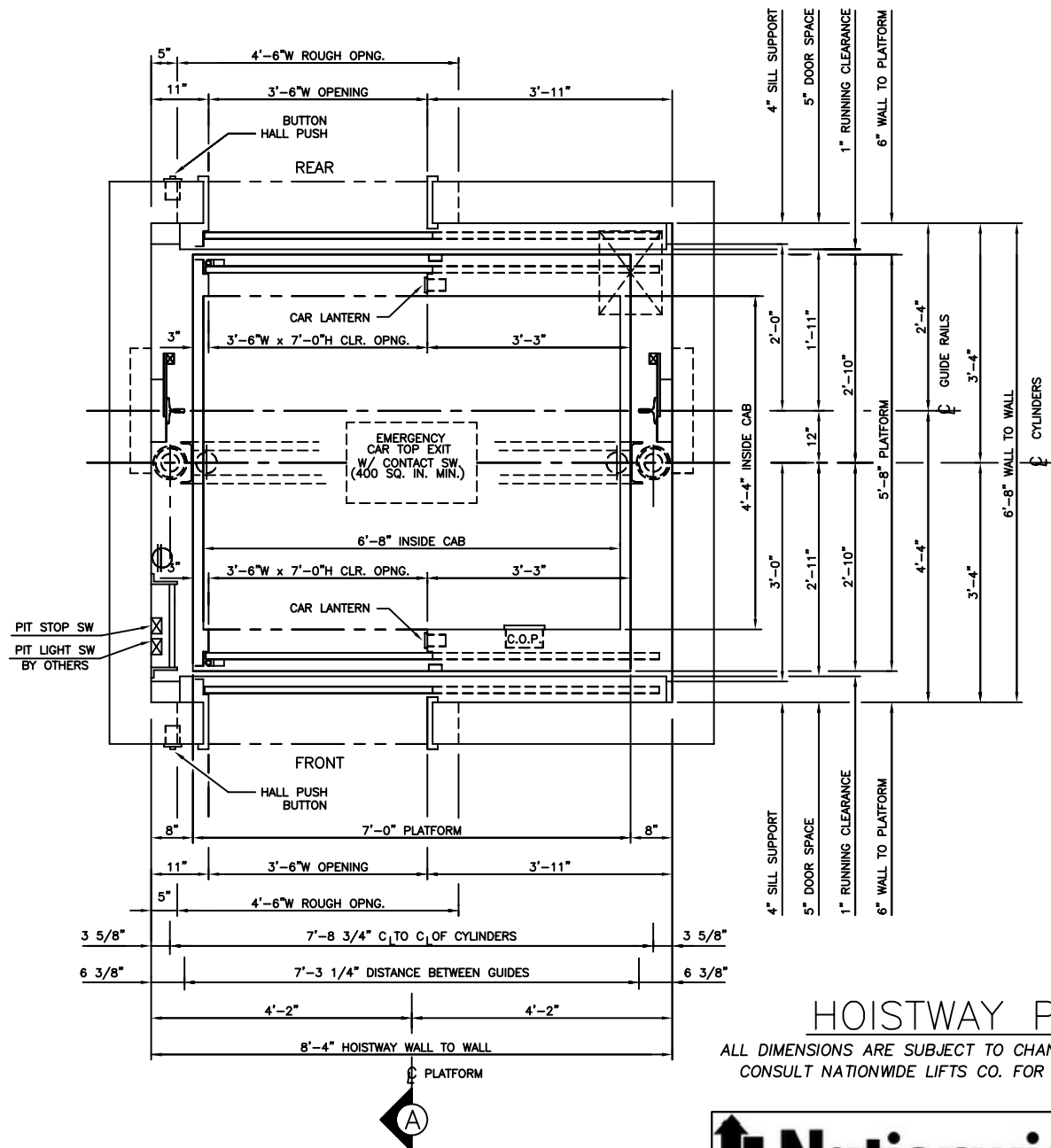

NOTE: HOISTWAY WIDTH AND DISTANCE FROM PLATFORM TO HOISTWAY WALL WILL VARY BASED ON SIZE OF JACK, TRAVEL, AND CAPACITY. CONSULT DEI ENGINEERING.

HOISTWAY PLAN
 ALL DIMENSIONS ARE SUBJECT TO CHANGE WITHOUT NOTICE.
 CONSULT NATIONWIDE LIFTS CO. FOR CONFIRMATION.

*2500 LBS. 2 STAGE HOLELESS HYDRAULIC
 FRONT & REAR LEFT OPENING*



P: 888-695-4387, E: info@elevators.com

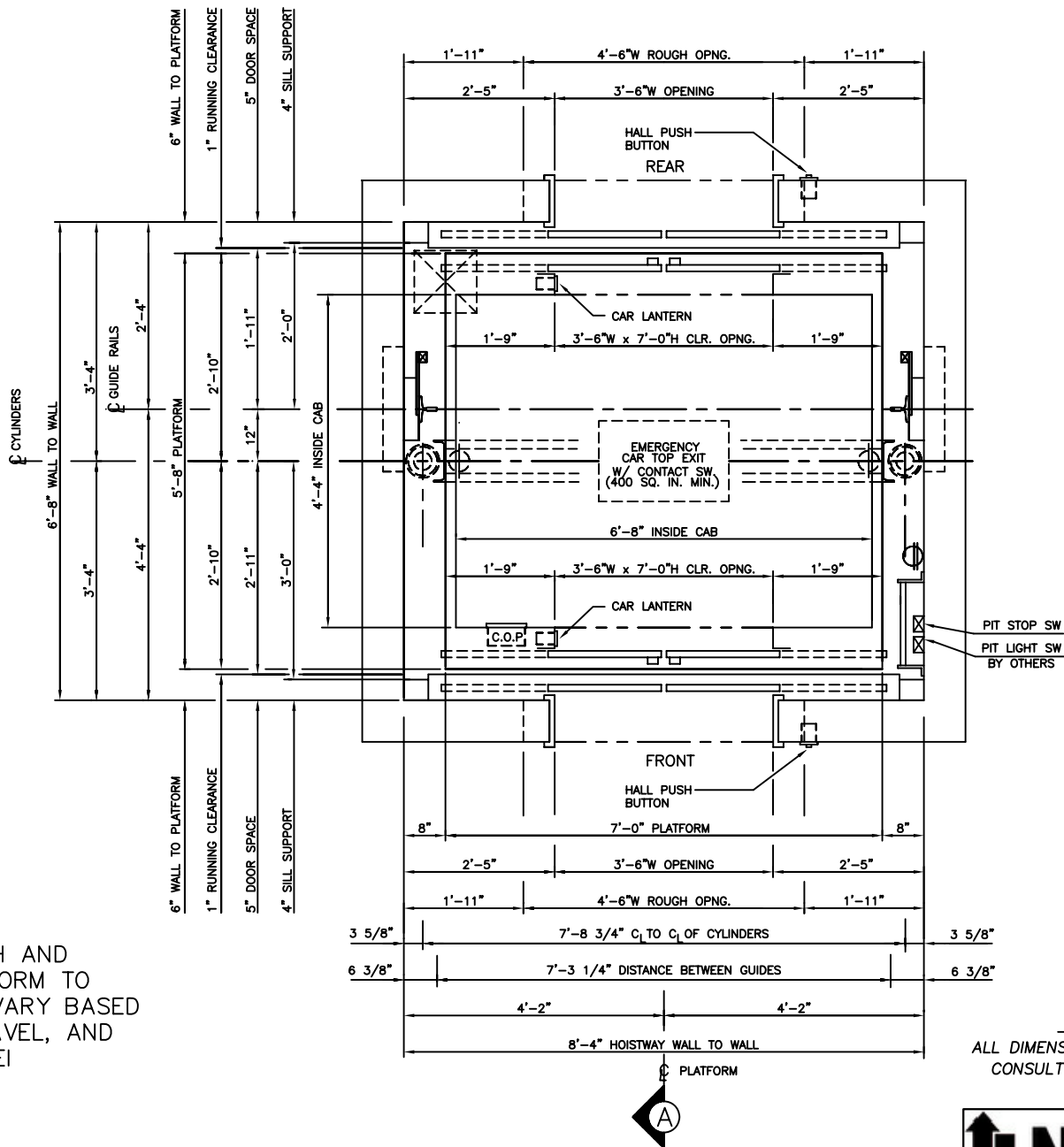

NOTE: HOISTWAY WIDTH AND DISTANCE FROM PLATFORM TO HOISTWAY WALL WILL VARY BASED ON SIZE OF JACK, TRAVEL, AND CAPACITY. CONSULT DEI ENGINEERING.

*2500 LBS. 2 STAGE HOLELESS HYDRAULIC
FRONT & REAR CENTER OPENING*

HOISTWAY PLAN
ALL DIMENSIONS ARE SUBJECT TO CHANGE WITHOUT NOTICE.
CONSULT NATIONWIDE LIFTS CO. FOR CONFIRMATION.



P: 888-695-4387, E: info@elevators.com

2500 LBS. 2 STAGE HOLELESS HYDRAULIC FRONT & REAR OPENING

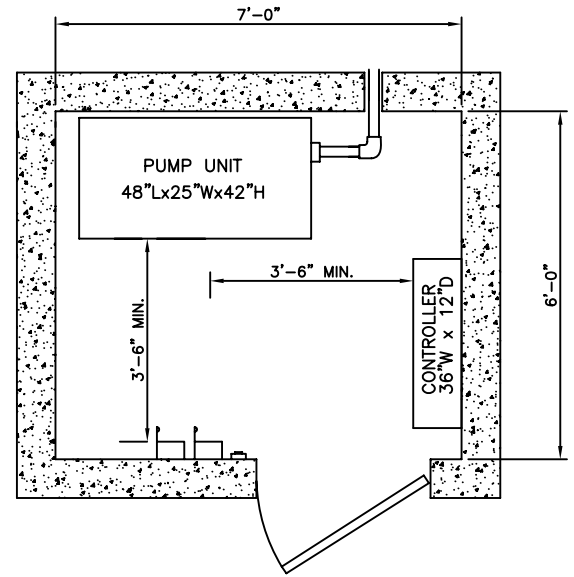
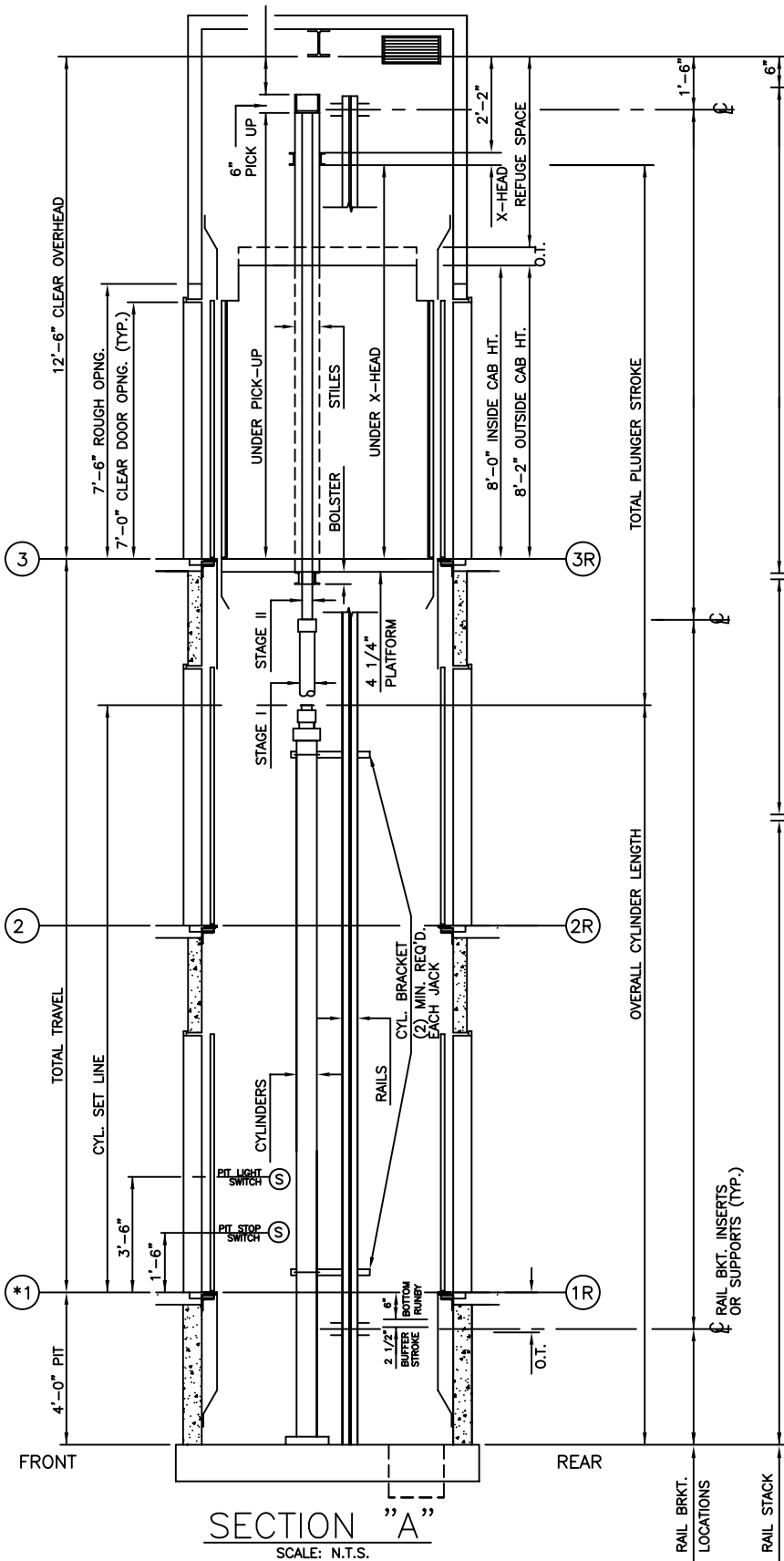

MACHINE ROOM DETAIL

ELEVATION PLAN

Nationwide Lifts
www.elevators.com

P: 888-695-4387, E: info@elevators.com