

8 7 6 5 4 3 2 1

D
C
B
A

D
C
B
A

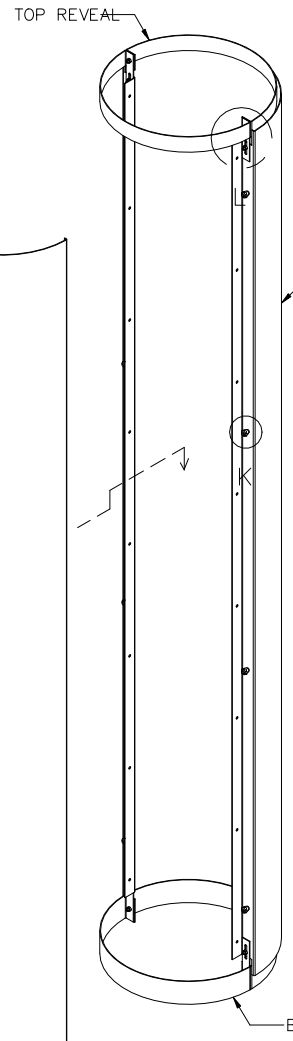
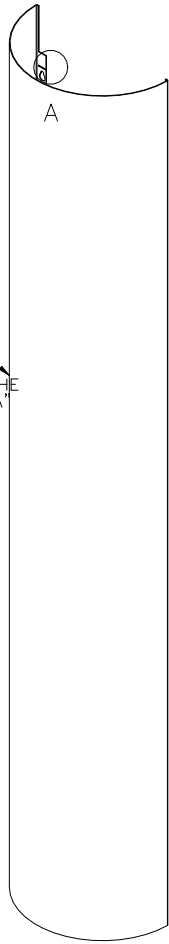
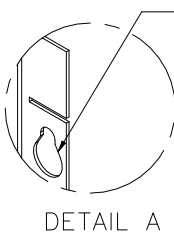

COVER "B" (WITH KEY HOLES) LIFT OVER MOUNTING NUT AND PUSHING DOWN TO SEAT ON THE SPACER WASHER ON COVER "A"

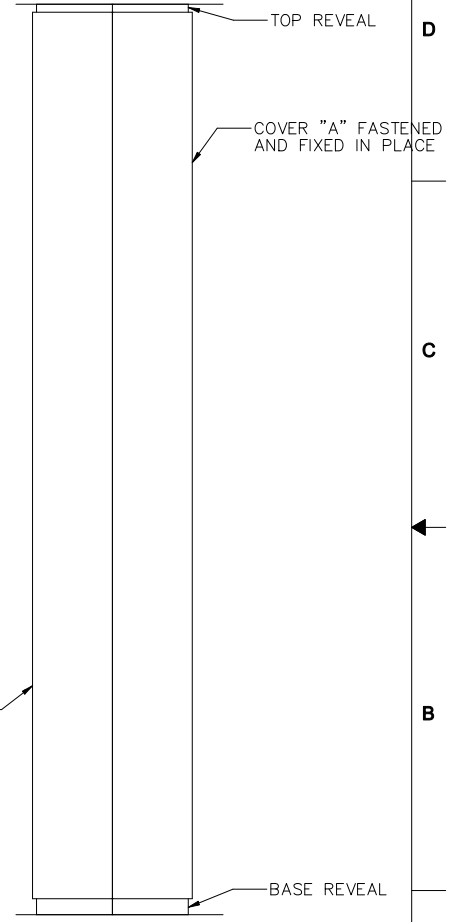
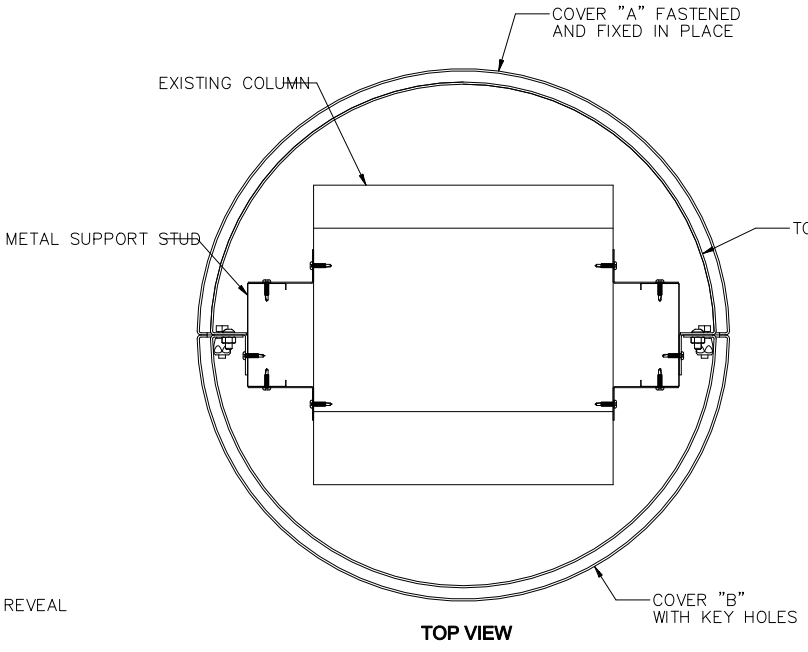
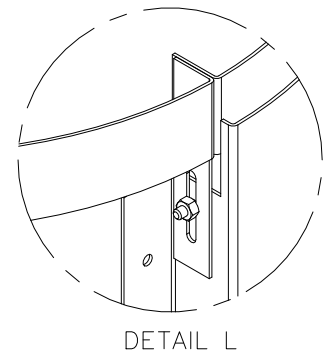
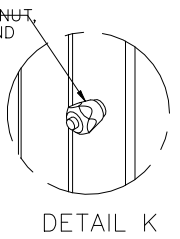

COVER "B" WITH KEY HOLES

NuvoFlute-V

| NO. | DATE | REVISION |
|-----------|------|----------|
| REVISIONS | | |

| | | | | | | |
|---|---|-----------------------------------|----------------------------|------------------------------------|--|--|
| <p>These are the sole and exclusive property of Nelson Industrial Inc. and the information contained herein may be used only by authorized agents. The use of these drawings for unintended applications, unauthorized alterations performed by third parties - on electronic files or hard copies - as well as disclosure and dissemination of information without prior consent are strictly prohibited and will absolve Nelson Industrial Inc. of any resulting liability.</p> | <p>STANDARD INFO. TOLERANCES ARE: UP TO 40PLG +/- .015 OVER 40PLG +/- .021 ANGLES: +/- 0.5 DEG. HOLE: +/- .005-.008 UNLESS OTHERWISE SPECIFIED ON THE DRAWING, ANGLES NOT DIMENSIONED ARE 90 DEG.</p> | <p>RETBACK</p> | <p>REV. INFO NUMBER</p> | <p>PART NO.</p> | <p>DESCRIPTION COLUMN COVER WITH SOFT "V" BUTT JOINT</p> | |
| | <p>MATERIAL</p> | <p>SCALE SHEET SCALE 1:20</p> | <p>DATE 07/07/2020</p> | <p>APPROVED</p> | <p>DATE</p> | |
| | <p>FINISH</p> | <p>PROJECTION THIRD ANGLE</p> | <p>WEIGHT</p> | <p>RELEASE DATE 19/11/2020</p> | <p>SIZE B</p> | <p>DWG NO. COLUMN COVER-BUTT JOINT</p> |
| | <p>THIRD ANGLE</p> | <p>19/11/2020</p> | <p>1 of 1</p> | <p>REV A</p> | | |

8 7 6 5 4 3 2 1