

REV	ECO	DESCRIPTION	DATE	DRFT	CHKD
C	12488	UPDATED	10/01/14	LS	BP

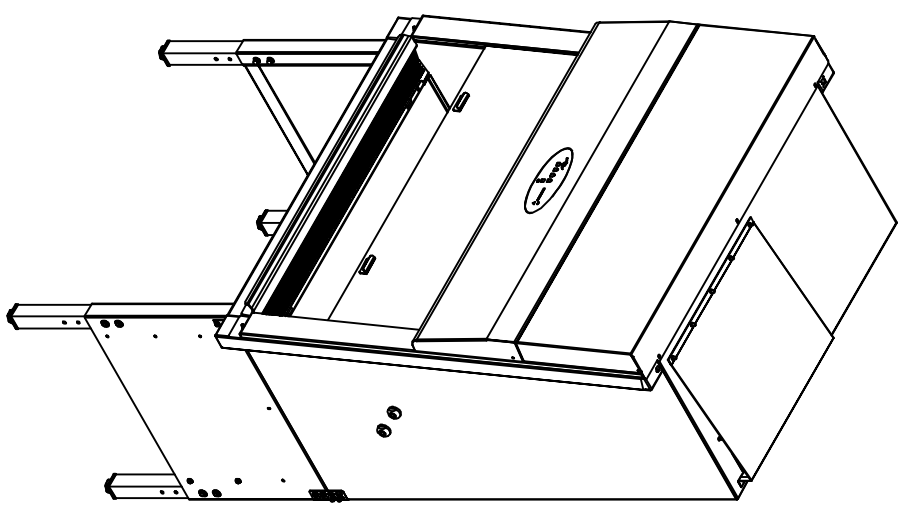

* OVERALL DIMENSIONAL TOLERANCE ±1/4 [6.35]
 ALL OTHER DIMENSIONS ±1/8 [3.17]

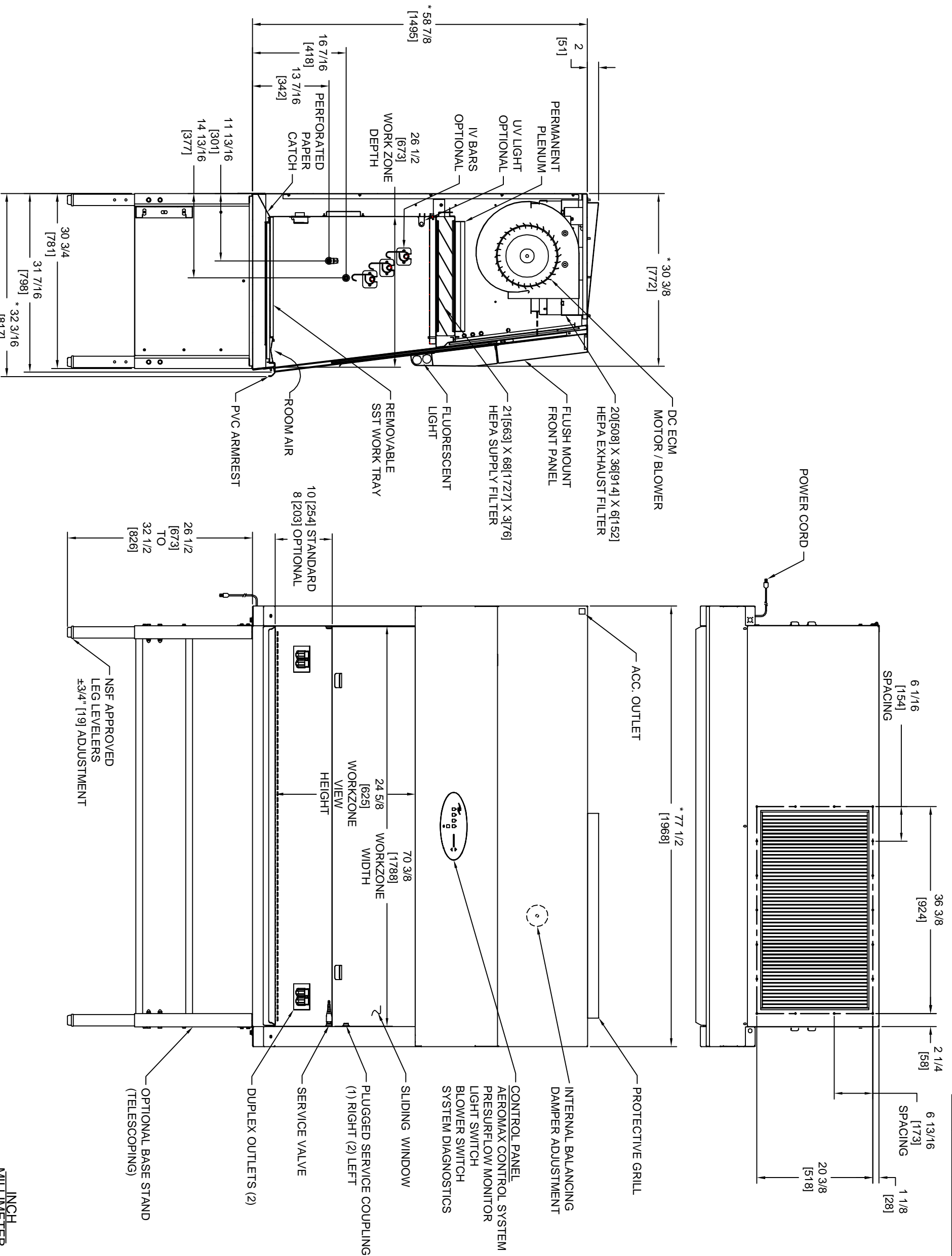

NU-540-600
 CLASS II, TYPE A2 (ENERGY SAVER)
 BIOLOGICAL SAFETY CABINET

DFTM	LS	12/16/2013	CHKD	BP	SHEET	1 OF 1
DRAWING NUMBER						BCD-16516
						C

INCH
 MILLIMETER