

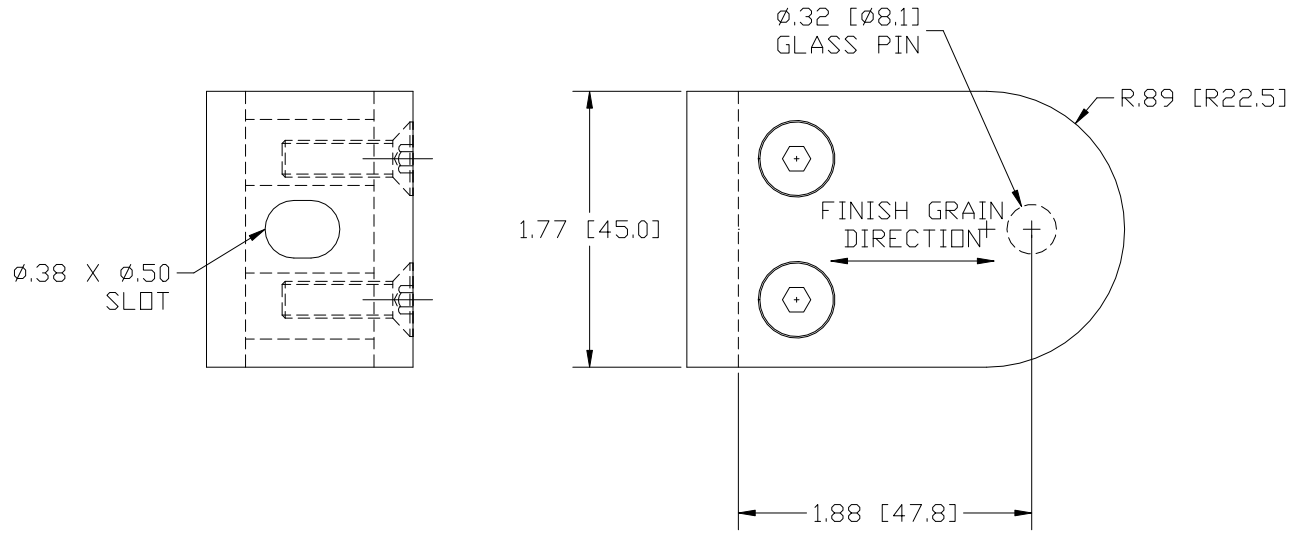

REV
SH
DWG NO GR305R.4-R

REVISIONS			
REV	DESCRIPTION	DATE	APPROVED

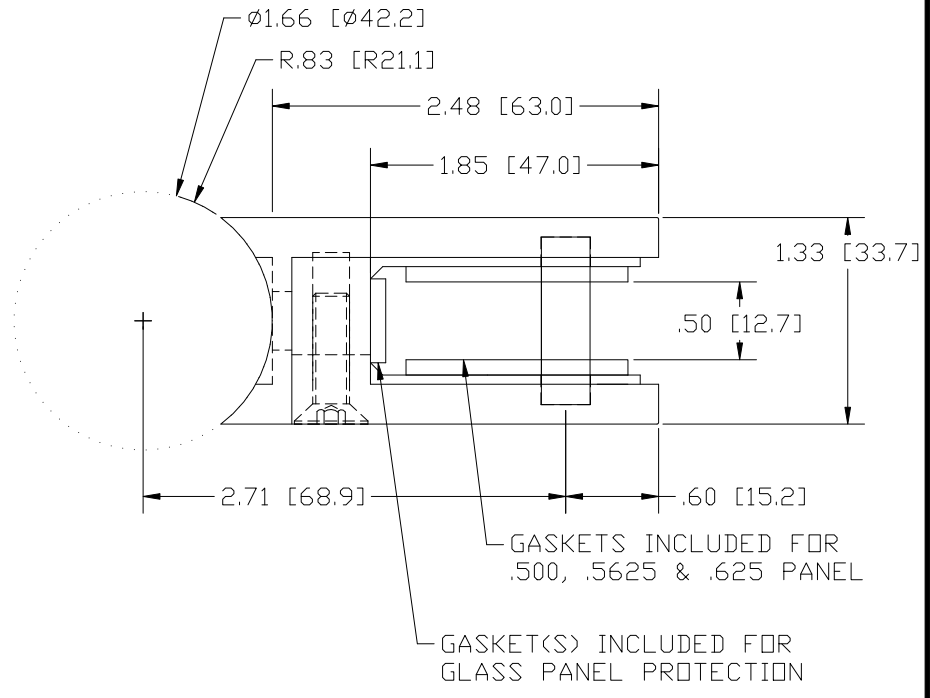

FOR GLASS THICKNESS 1/2" - 5/8"
WORKS WITH POST SIZES 1.50" - 1.66" DIAMETER

PART NAME		GLASS CLIP ASSEMBLY	
MATERIAL		TYPE 316 STAINLESS STEEL	
DATE	01/03/14	 THE WAGNER COMPANIES R & B WAGNER, INC. AND J. G. BRAUN CO.	
DRAWN BY	TLK		
FINISH	#4 SATIN		
SIZE	A	PART NUMBER	GR305R.4-R
			REV