

REVISIONS			
REV	DESCRIPTION	DATE	APPROVED

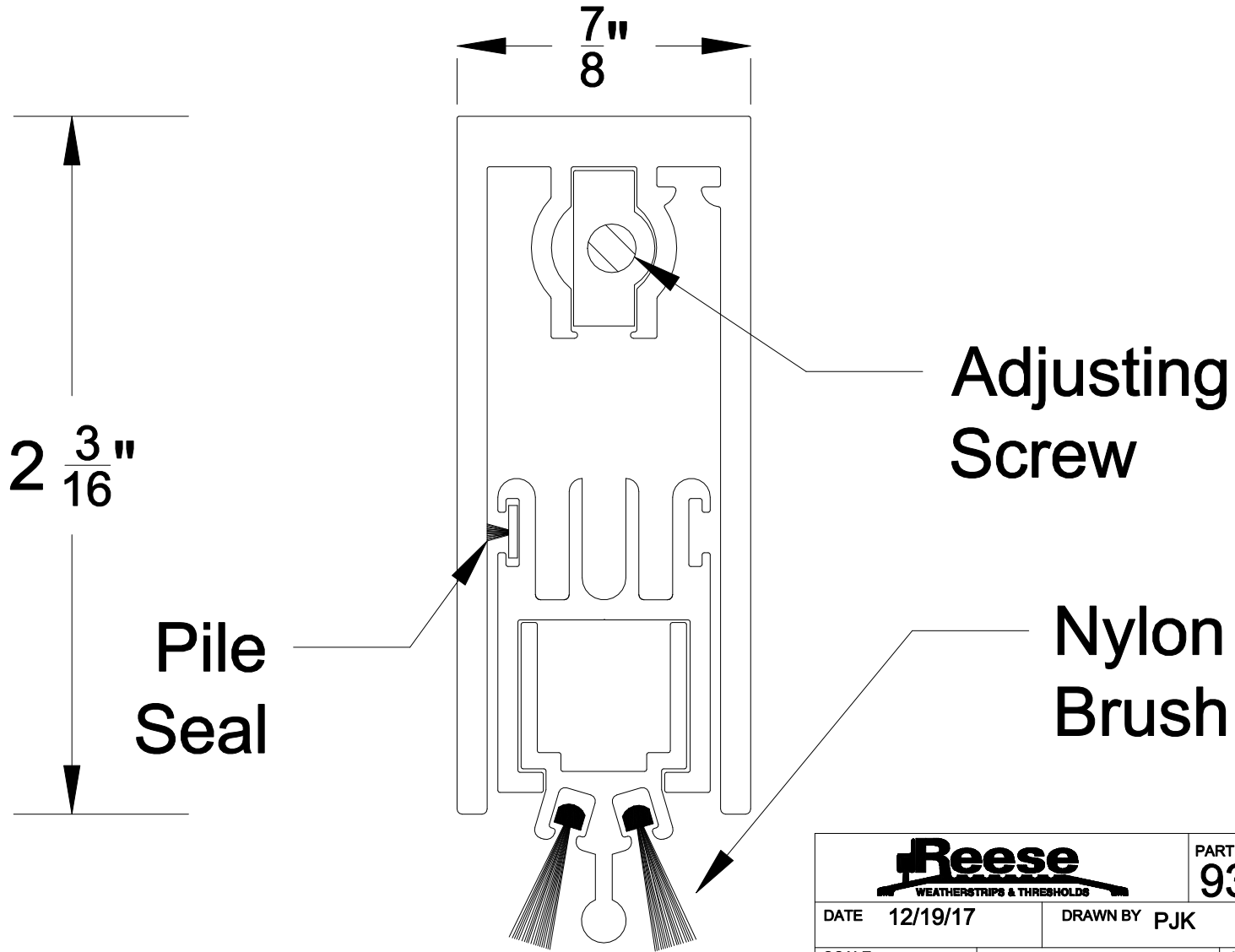

Reese WEATHERSTRIPS & THRESHOLDS		PART NO. 933
DATE 12/19/17	DRAWN BY PJK	APPROVED
SCALE 2:1	INSERT MATERIAL Nylon Brush	ALUMINUM ALLOY 6063 T-5