

THERMATITE T300-MR

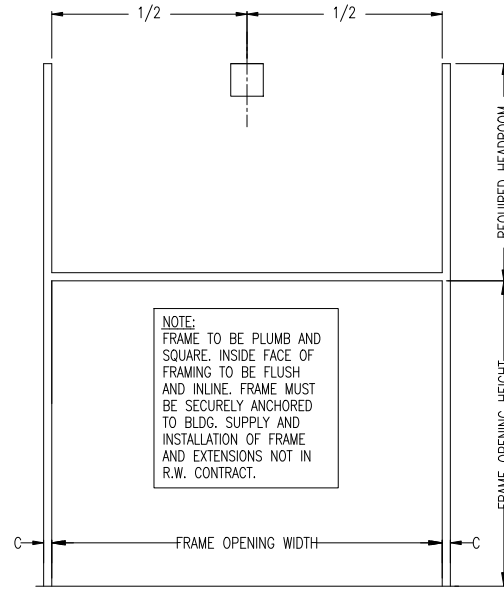

INTERIOR ELEVATION OF FRAMING BY OTHERS

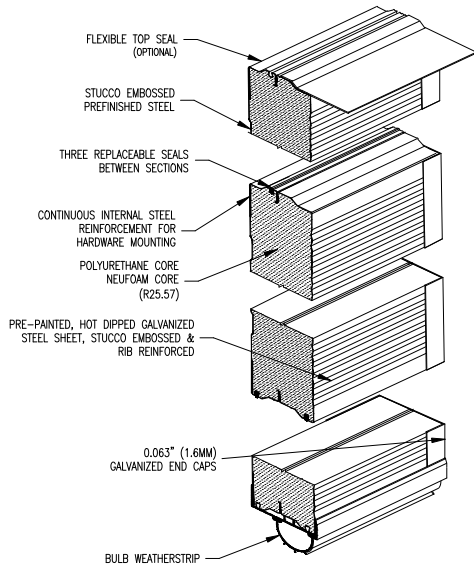
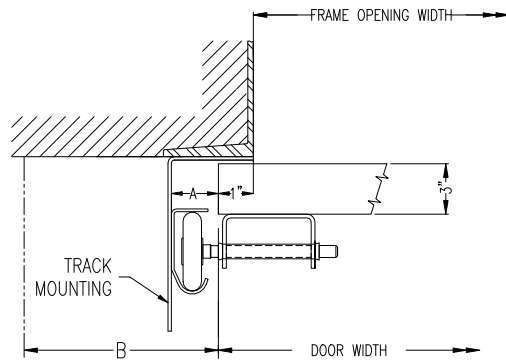

STEEL JAMB DETAILS

ISSUE NO.	REV. LET.	ISSUES OR REVISIONS	DATE	BY	APP.
1					

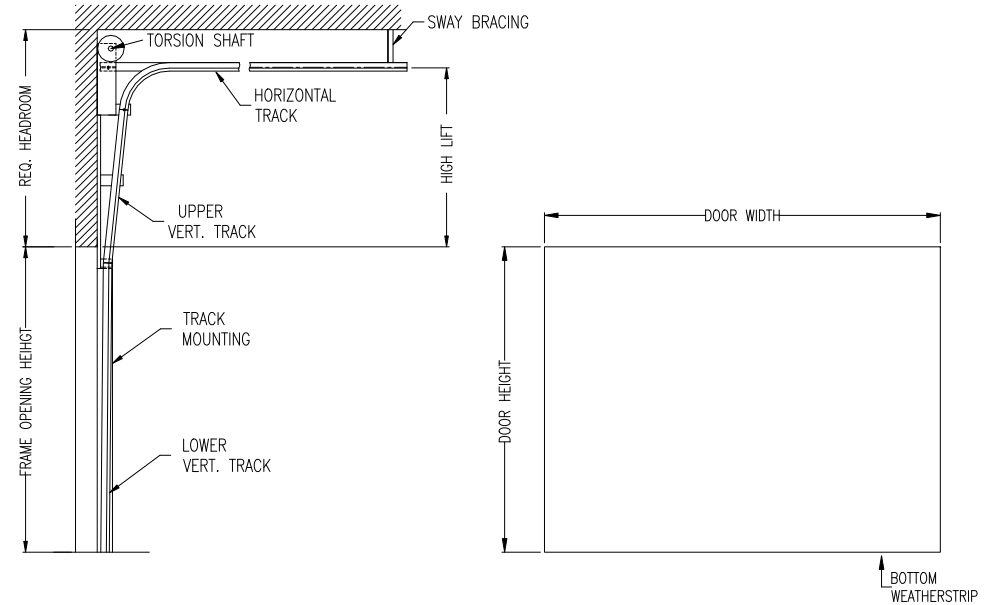

CROSS SECTION

EXTERIOR ELEVATION

DOOR WIDTH		ADCA	A	B	C	TRUSSING	WIND LOAD
DOOR HEIGHT		2"	1 1/2"	3 1/2"	2 1/2"		
FRAME OPENING WIDTH		3"	2"	4"	3"	OPTIONS	
FRAME OPENING HEIGHT		LOWER VERTICAL TRACK					
HIGH LIFT		UPPER VERTICAL TRACK					
HEADROOM REQ'D.		HORIZONTAL TRACK ___" RADIUS					
TRACK MOUNTING	<input type="checkbox"/> ADCA <input type="checkbox"/> BRACKET	LITES					

TITLE	THERMATITE T300-MR DOOR C/W ___" HIGH LIFT HARDWARE						
CLIENT							
SETS REQUIRED	TAG						
CLIENT'S ORDER NO.	R-W ORDER NO.						

Richards-Wilcox CANADA INC. TORONTO, ONTARIO	DRAWN			SCALE	NTS
	CHECKED			DRAWING NO.	
	APPROVED			SHEET NO.	