

1-TREAD

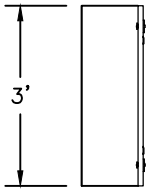

TOP VIEW

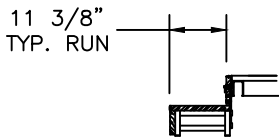

SIDE VIEW

2-TREAD

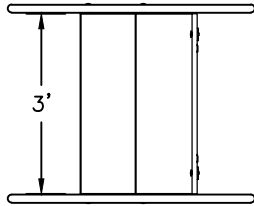

TOP VIEW

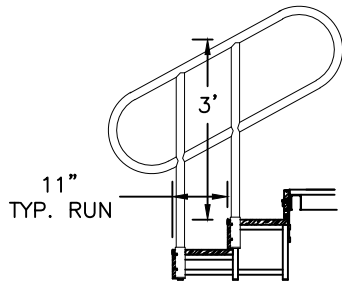

SIDE VIEW

3-TREAD

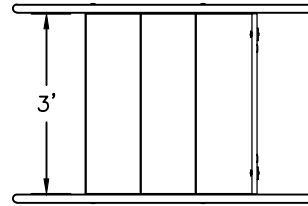

TOP VIEW

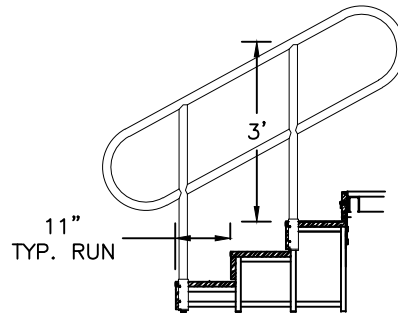

SIDE VIEW

4-TREAD

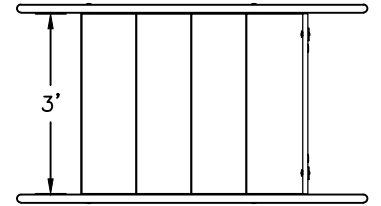

TOP VIEW

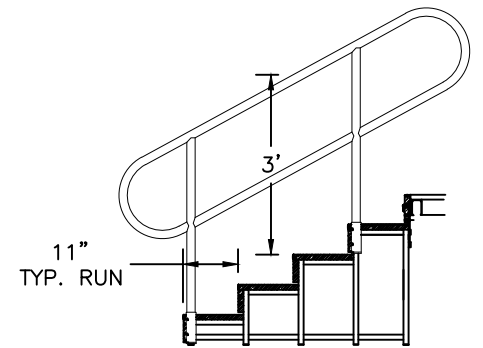

SIDE VIEW

ITEM	DATE	DESCRIPTION OF CHANGE	AUTH.

	CORPORATE OFFICE 7008 Northland Dr. Suite 150 Brooklyn Park, Minnesota 55428 PH: (763) 533-2094
	MATERIAL

TITLE
**FIXED HEIGHT
 STAIR UNITS**

THIS DRAWING IS THE PROPERTY OF
 STAGING CONCEPTS, INC AND IS
 FURNISHED ON A CONFIDENTIAL BASIS.
 NEITHER THE DRAWING NOR ITEMS
 THEREON ARE TO BE REPRODUCED
 OR USED IN ANY MANNER NOT
 AUTHORIZED BY STAGING CONCEPTS
 AND IS LOANED SUBJECT TO
 RETURN ON DEMAND

DR. BY	DATE
SCALE	
UNSPECIFIED TOLERANCES ARE TO BE LINEAR ANGULAR	

PROJECT
PRODUCT
NUMBER