

LEGEND:
1: 1.125" ELECTRICAL
2: EXHAUST OUTLET

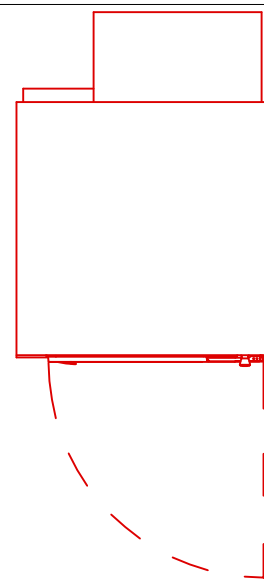

PLAN VIEW

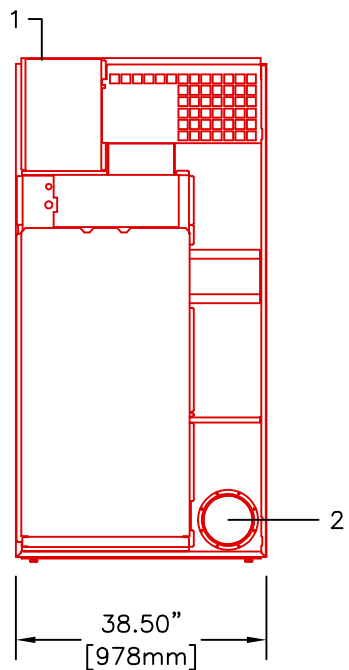

REAR VIEW

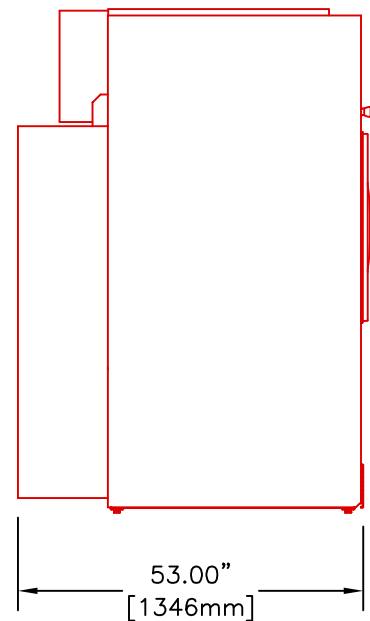

LEFT SIDE VIEW

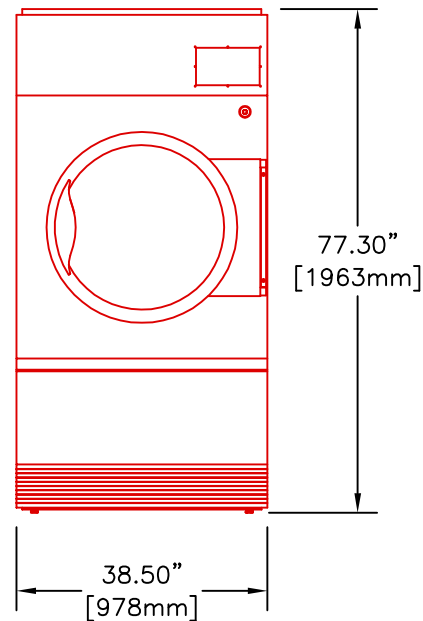

FRONT VIEW

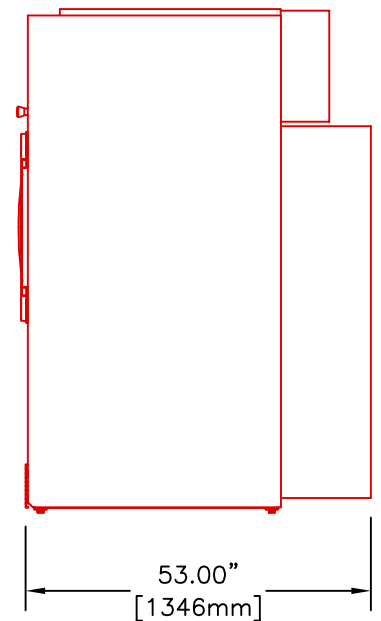

RIGHT SIDE VIEW

75 LB. TUMBLE DRYER (ELECTRIC HEATED)



Equipment specifications are subject to change without notice. Please use this drawing along with the installation manuals for updated equipment installation requirements.

KRP	CAD BLOCK	2-Apr-18
Drawn by	Description	Date