

LEGEND:	
1: HARD COLD WATER INLET	5: COMPRESSED AIR INLET
2: SOFT COLD WATER INLET	6: ENTRY MAIN POWER
3: HOT WATER INLET	7: DRAIN OUTLETS
4: STEAM INLET	

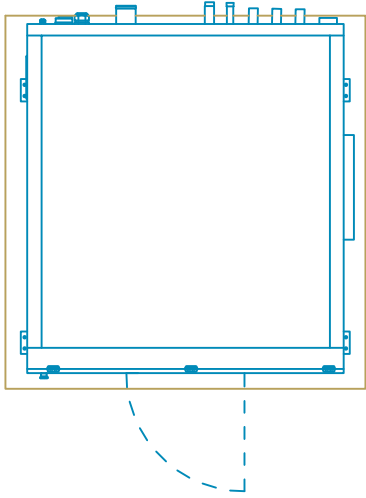

PLAN VIEW

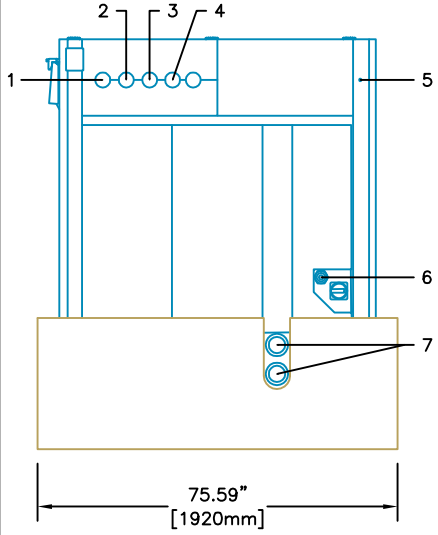

REAR VIEW

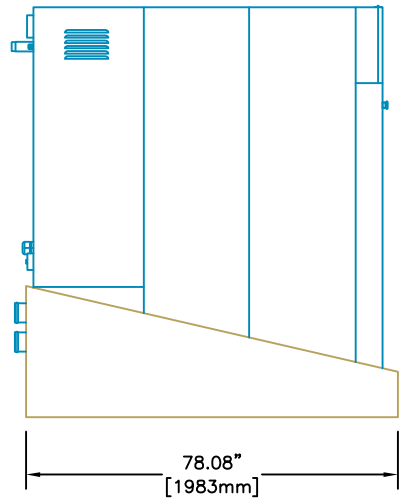

LEFT SIDE VIEW

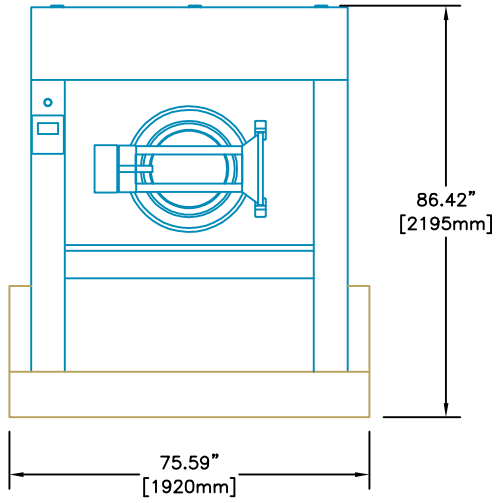

FRONT VIEW

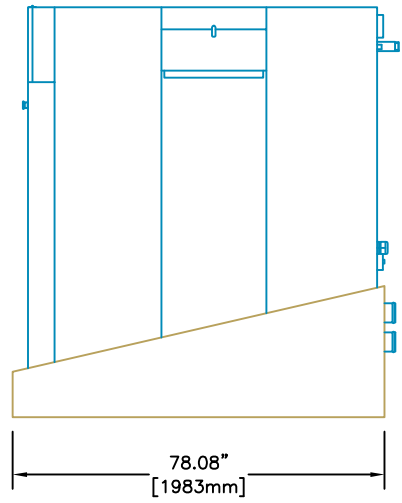

RIGHT SIDE VIEW

230 lb. TILTING CABINET FREESTANDING WASHER-EXTRACTOR



Equipment specifications are subject to change without notice. Please use this drawing along with the installation manuals for updated equipment installation requirements.

KRP	CAD BLOCK	10-Jan-18
Drawn by	Description	Date