

LEGEND:

- | | |
|--------------------------|--------------------------|
| 1: DRAIN OUTLET | 5: COLD HARD WATER INLET |
| 2: STEAM CONNECTION | 6: ELECTRICAL CONNECTION |
| 3: RECYCLED WATER INLET | 7: HOT WATER INLET |
| 4: COLD SOFT WATER INLET | |

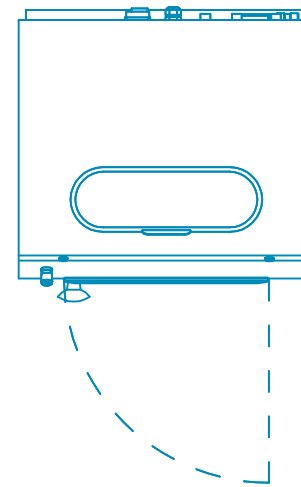

PLAN VIEW

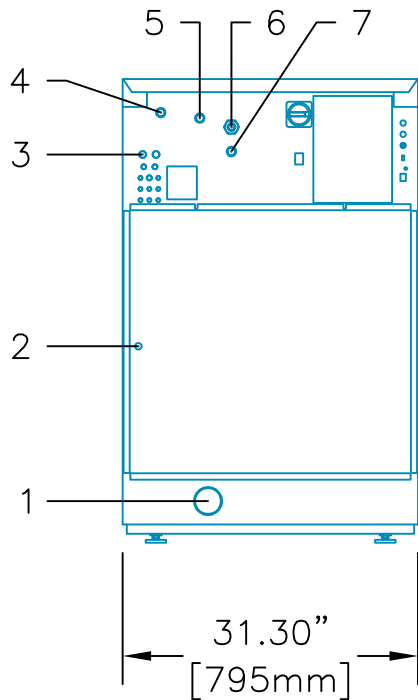

REAR VIEW

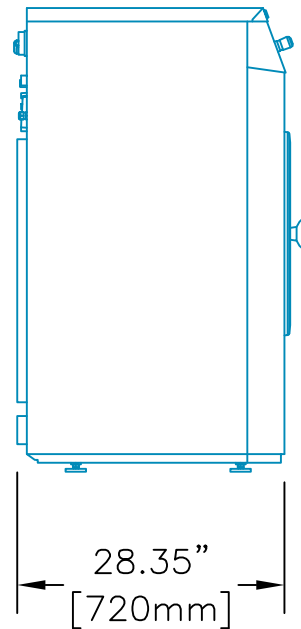

LEFT SIDE VIEW

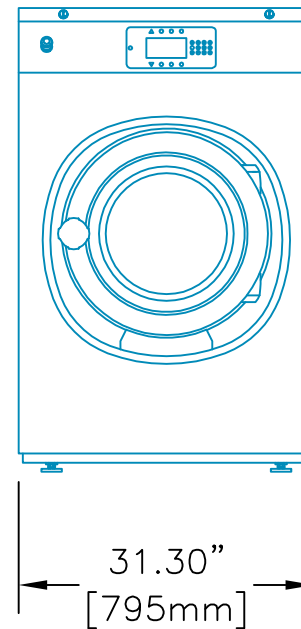

FRONT VIEW

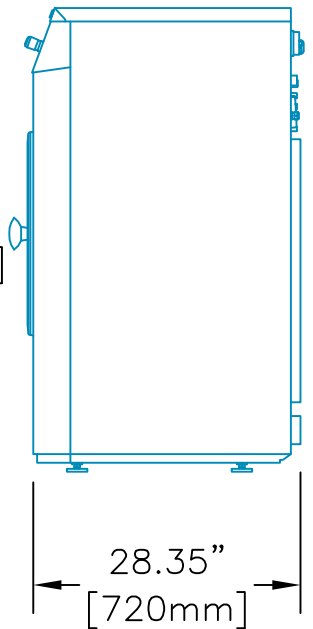

RIGHT SIDE VIEW

**25 lb. CABINET
FREESTANDING
WASHER-EXTRACTOR**



Equipment specifications are subject to change without notice. Please use this drawing along with the installation manuals for updated equipment installation requirements.

KRP	CAD BLOCK	10-Jan-18
Drawn by	Description	Date