

LEGEND:	
1: DRAIN OUTLET	5: COLD HARD WATER INLET
2: STEAM CONNECTION	6: ELECTRICAL CONNECTION
3: RECYCLED WATER INLET	7: HOT WATER INLET
4: COLD SOFT WATER INLET	

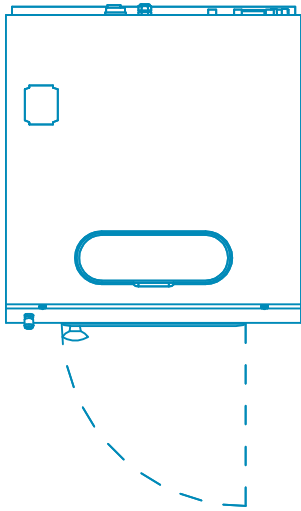

PLAN VIEW

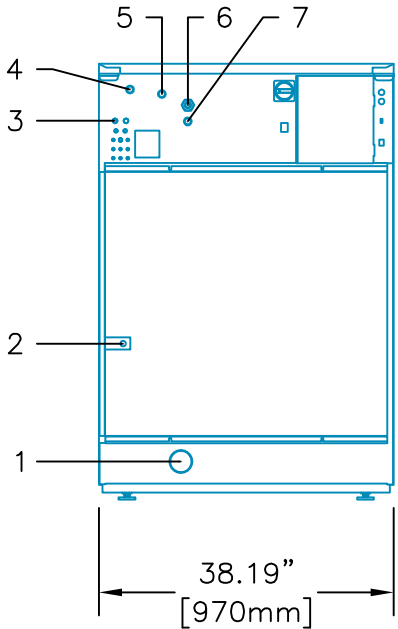

REAR VIEW

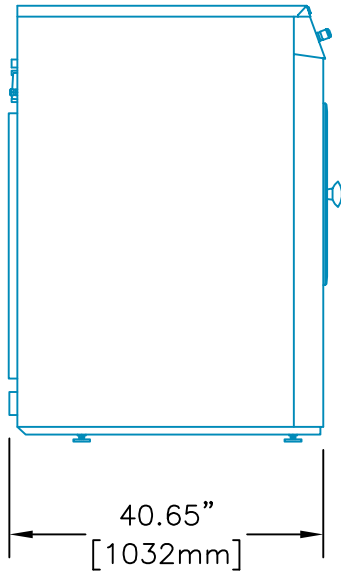

LEFT SIDE VIEW

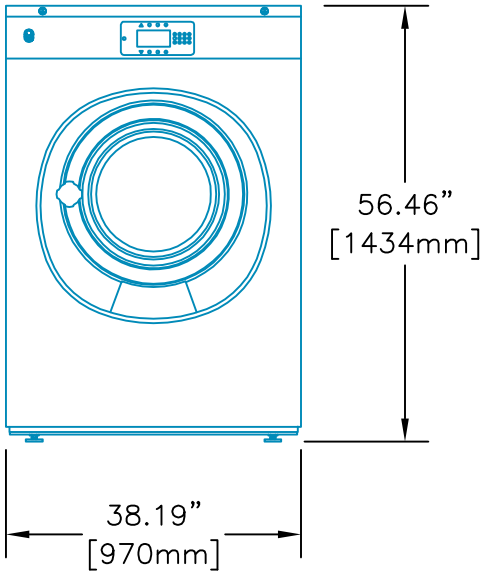

FRONT VIEW

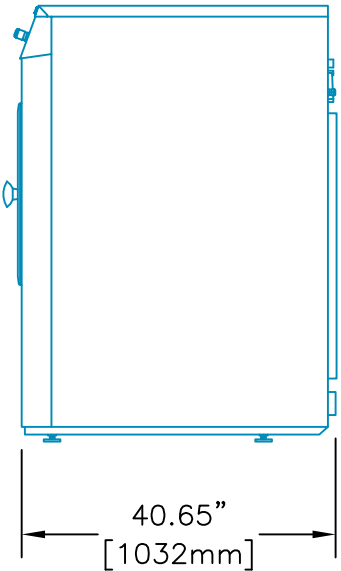

RIGHT SIDE VIEW

55 lb. CABINET FREESTANDING WASHER-EXTRACTOR



Equipment specifications are subject to change without notice. Please use this drawing along with the installation manuals for updated equipment installation requirements.

KRP	CAD BLOCK	10-Jan-18
Drawn by	Description	Date