

LEGEND:	
1: ENTRY MAIN POWER	5: COMPRESSED AIR INLET (IF EQUIPPED)
2: HARD COLD WATER INLET	6: STEAM INLET
3: HOT WATER INLET	7: DRAIN OUTLETS
4: SOFT COLD WATER INLET	

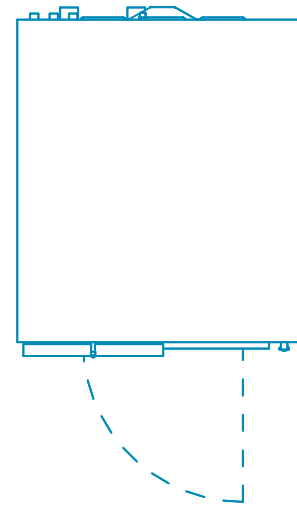

PLAN VIEW

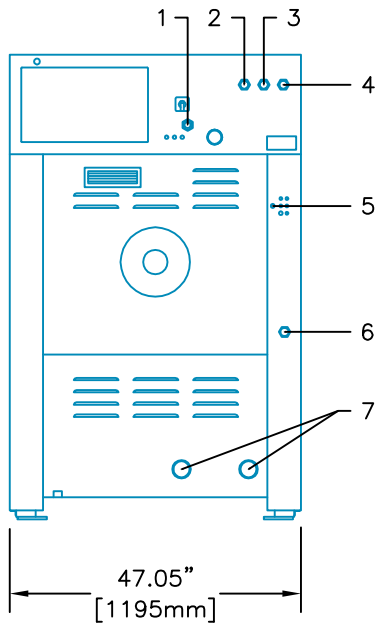

REAR VIEW

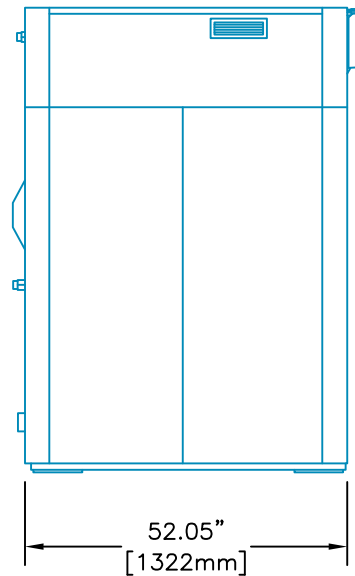

LEFT SIDE VIEW

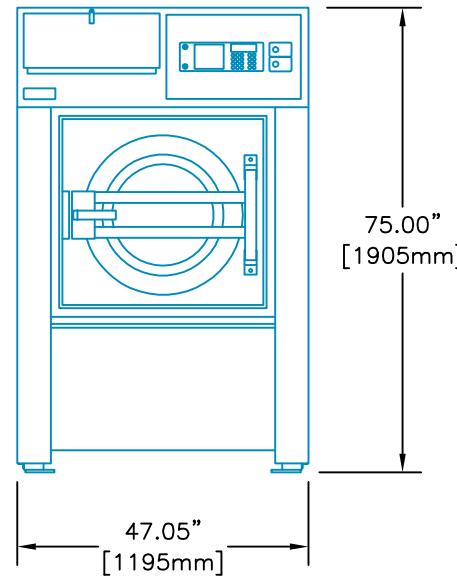

FRONT VIEW

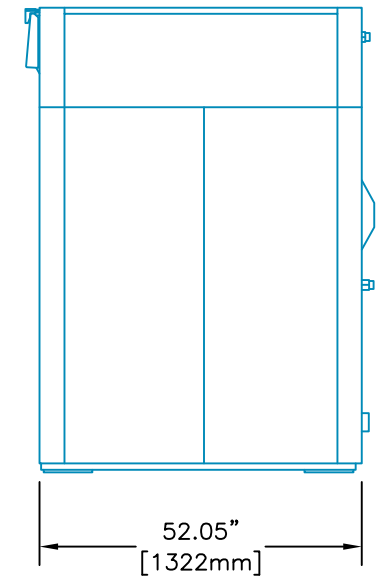

RIGHT SIDE VIEW

90 lb. CABINET FREESTANDING WASHER-EXTRACTOR



Equipment specifications are subject to change without notice. Please use this drawing along with the installation manuals for updated equipment installation requirements.

KRP	CAD BLOCK	8-Jan-18
Drawn by	Description	Date