

Horizontal Support Spacing Requirements for Uponor PEX Pipe:

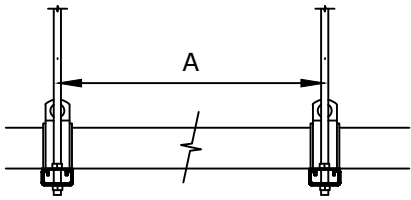

Maximum Allowable Support Spacing for Bare-PEX Pipe

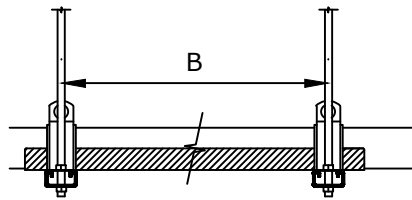

Maximum Allowable Support Spacing for PEX Pipe with PEX-a Pipe Support

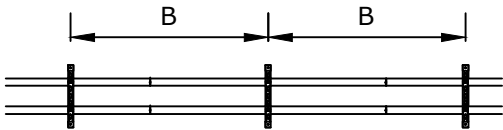

PEX-a Pipe Support without Fittings

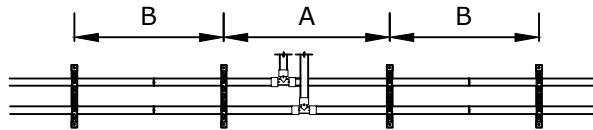

PEX-a Pipe Support with Fittings

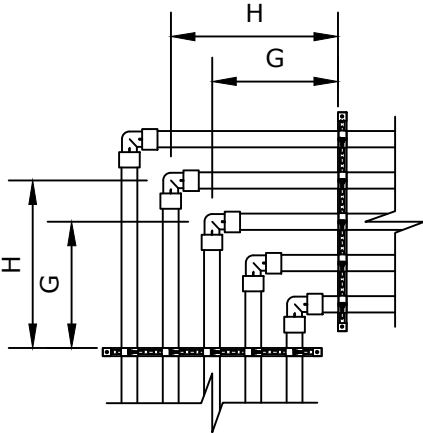

Corner Support Example

Distance G = 16"
 Total distance for G = 32"
 (16 + 16)
 Distance H = > 16"
 Total distance for H = > 32"

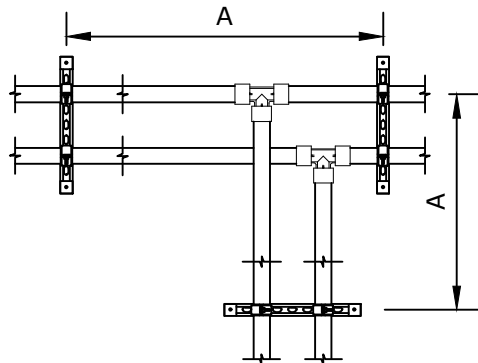

Support Requirements for Fittings

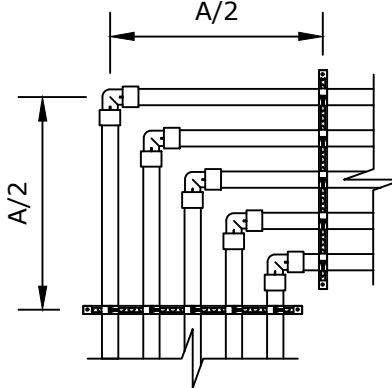

Support Requirements for Fittings at Corners

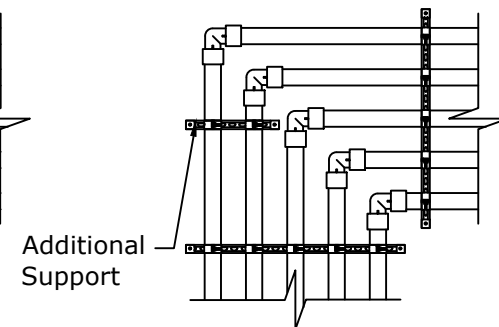

Additional Support

Additional Support Requirements for Fittings at Corners

Nominal Pipe Size	Spacing for Bare PEX-Dimension "A"			Spacing w/ PEX-a Pipe Support-Dimension "B"			Dimension "C"
	IPC	UPC	NPCC	IPC	UPC	NPCC	All Codes
1/2"	32"	32"	32"	6'-0"	6'-0"	6'-0"	--
3/4"	32"	32"	32"	6'-0"	6'-0"	6'-0"	--
1"	32"	32"	32"	8'-0"	8'-0"	8'-0"	--
1 1/4"	32"	48"	32"	8'-0"	8'-0"	8'-0"	18"
1 1/2"	32"	48"	32"	8'-0"	8'-0"	8'-0"	18"
2"	32"	48"	32"	8'-0"	8'-0"	8'-0"	18"
2 1/2"	32"	48"	32"	8'-0"	8'-0"	8'-0"	7"
3"	32"	48"	32"	8'-0"	8'-0"	8'-0"	7"

Uponor Spacing Requirements

REVISIONS				CAD GENERATED DRAWING, DO NOT MANUALLY UPDATE	
REV	ECO #	DATE	ENG	DO NOT SCALE DRAWING	
--	--	--	--	THE INFORMATION CONTAINED IN THIS DRAWING IS THE SOLE PROPERTY OF UPONOR. ANY REPRODUCTION IN PART OR WHOLE WITHOUT THE WRITTEN PERMISSION OF UPONOR IS PROHIBITED.	
--	--	--	--		
--	--	--	--		
--	--	--	--		
--	--	--	--		
				APPROVALS	DATE
				DRAWN BY	
				DESIGNER	02/02/2016
				APPROVED BY	
				APPROVED	

Uponor
 5925 148TH STREET WEST
 APPLE VALLEY, MN 55124
 PHONE (952) 891-2000
 FAX (952) 997-1731

SUPPORTING PIPE & FITTINGS

SIZE/DESCRIPTION	REV
A SUPPORTING PIPE & FITTINGS	00
SCALE 1:1	SHEET 1 of 1