

Colors: Black (BK)  
 Brown (BR)  
 Grey (GR)  
 Ivory (IV)  
 White (WH)

Elegant (CL) Roller Shade Clutch, HM

0-154-CL-V15XX

XX=COLOR

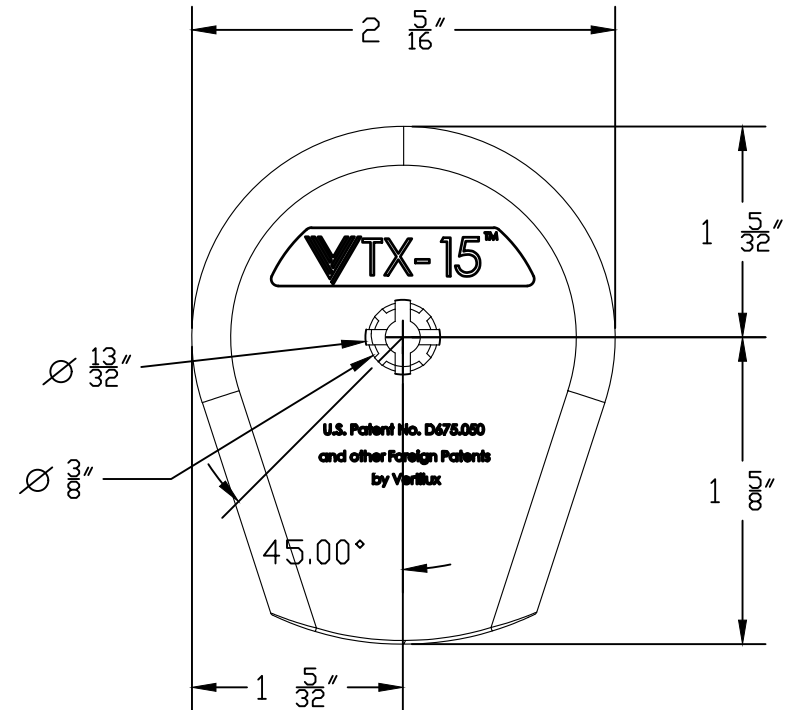
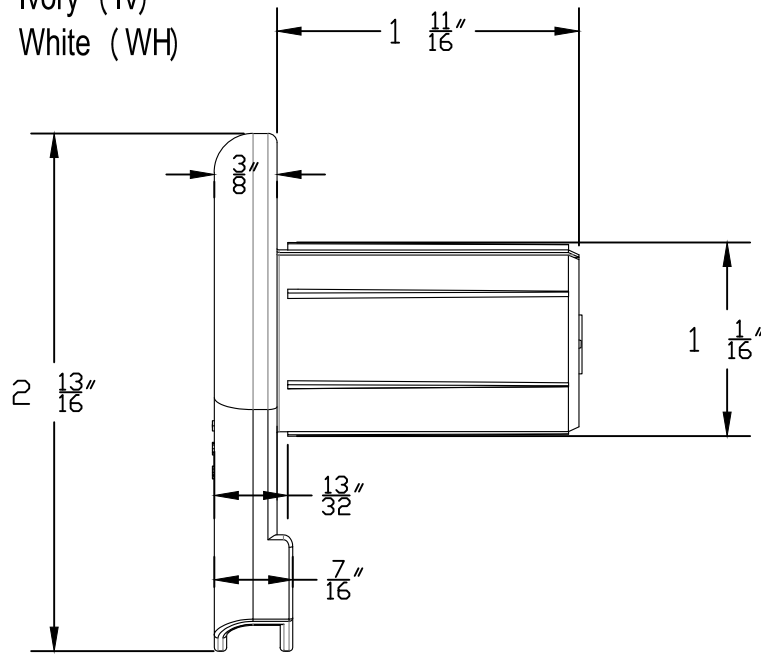

Note: Dimensions are in Inches

Tolerance is  $\pm 0.002$ " /0.05 mm

It will need adapter 0-154-AD-V32XX for 1 1/4"/32mm tubes  
 or adapter 0-154-AD-V38XX for 1 1/2"/38mm tubes.

U.S. PATENT No. D675.050 AND OTHER FOREIGN PATENTS BY VERTILUX

**Vertilux** BLINDS & SHADES

MATERIAL

High Impact Nylon 6 With 30% Fiberglass

TITLE

VTX15 Tab Mount, Elegant  
 For 1 1/8"/ 28mm Tubes

Dimensions are subject to change without notice