

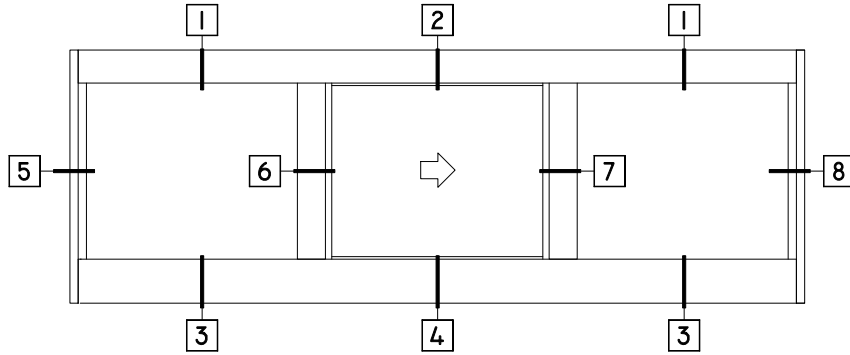

**WINTTECH**  
An Employee Owned Company

# 3210 OXO SLIDER - 10 LB SILL



**1** FX HEAD  
3210 HS

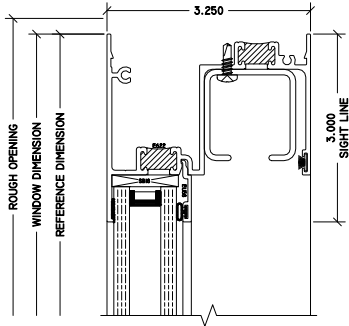

**2** OP HEAD  
3210 HS

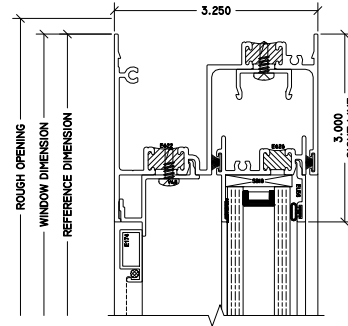

**3** FX SILL  
3210 HS

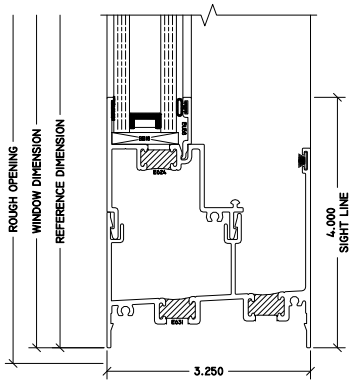

**4** OP SILL  
3210 HS

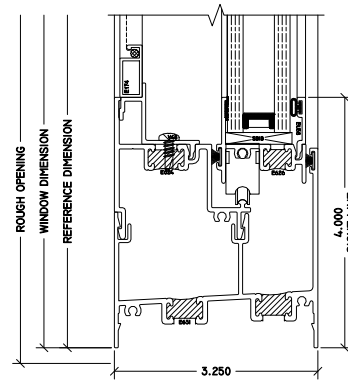

**5** FX JAMB  
3210 HS

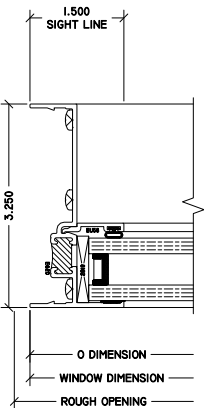

**6** OXO MTG RAIL  
3210 HS

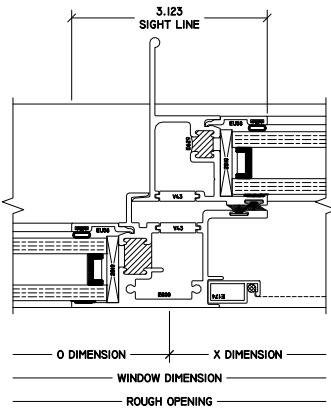

**7** XO MTG RAIL  
3210 HS

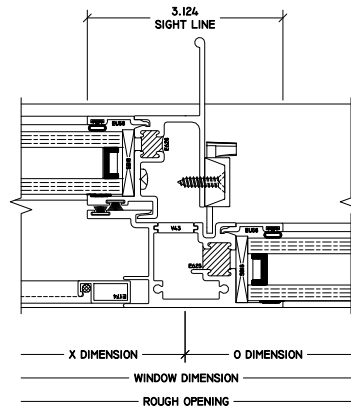

**8** FX JAMB  
3210 HS

