

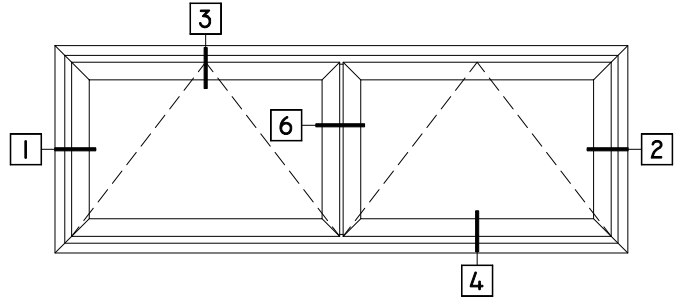

WINTECH
An Employee Owned Company

S251 PROJECT OUT

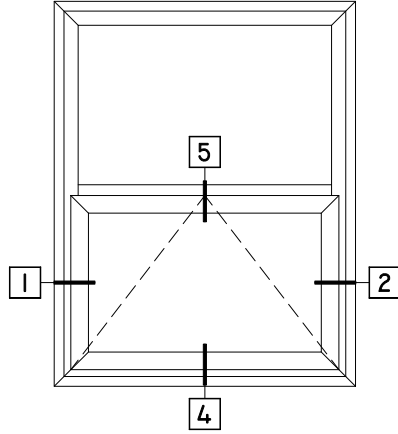
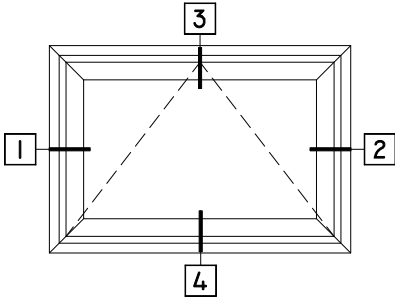

1 PO JAMB
S251 PO

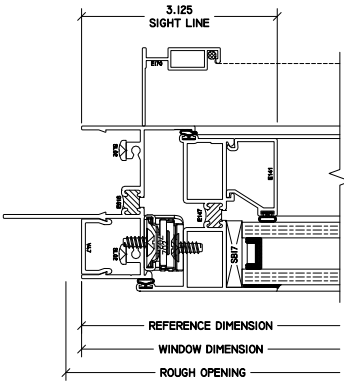

2 PO JAMB
S251 PO

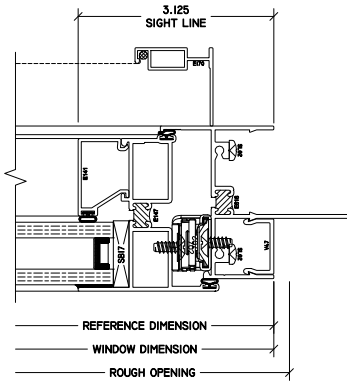

3 PO HEAD
S251 PO

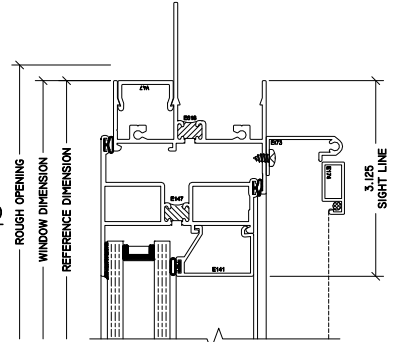

4 PO SILL
S251 PO

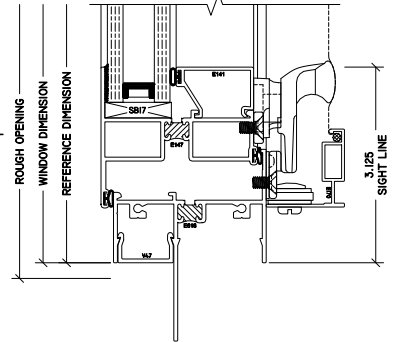

5 FX/PO MTG RAIL
S251 PO

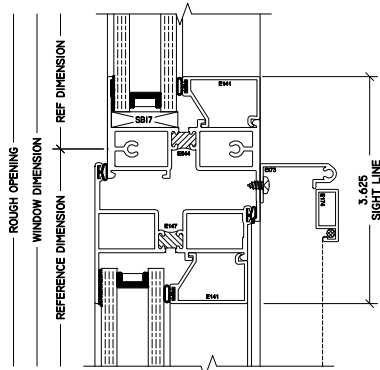

6 PO-PO MTG RAIL
S251 PO

